

The CJ2 Provides a Complete Lineup

The complete lineup provides high-performance features from machine control to information processing.

| Units | | CJ2M | | CJ2H | |
|---|------------------|---|---|---|---|
| Type | | Simple Types | Standard Types | High - end Types | Flagship Types |
| Models | | CJ2M-CPU1□ | CJ2M-CPU3□ | CJ2H-CPU6□ | CJ2H-CPU6□-EIP |
| Appearance | |  |  |  |  |
| Program Capacity | | Up to 60 Ksteps | | Up to 400 Ksteps | |
| Data Memory Capacity | | Up to 160 Kwords | | Up to 832 Kwords | |
| I/O Bits | | 2,560 | | | |
| Basic Instructions(LD) | | 40ns | | 16ns | |
| Special instruction (MOV) | | 120ns | | 48ns | |
| Floating-point decimal instructions (SIN) | | 0.86μs | | 0.59μs | |
| System overhead time | | 160μs | 270μs | 100μs | 200μs |
| FB Program Area | | YES (Equivalent to 20K steps.) | | — | |
| Communications Port | USB Port | YES | | | |
| | Serial Port | YES (RS-232C) | One Serial Option Board can be mounted (RS-232C or RS-422A/485) | YES (RS-232C) | |
| | EtherNet/IP Port | — | YES | — | YES |
| Serial PLC Links | | YES | YES (A Serial Option Board is required) | — | |
| High-speed Interrupt Function | | — | | YES | |
| Synchronous Unit Operation | | — | | YES (In combination with a CJ1W-NC□□4 Position Control Unit) | |
| Pulse I/O Modules* | | YES (Up to two Pulse I/O Modules can be mounted) | | — | |

*A Pulse I/O Module must be mounted for CJ2M CPU Units with unit version 2.0 or later.

■ Configuration Units

| CJ1 Basic I/O Units | | | |
|--|---|---|---|
| 8-point Units | 16-point Units | 32-point Units | 64-point Units |
| Input Units | | | |
| <ul style="list-style-type: none"> ● DC Input Unit CJ1W-ID201 ● AC Input Unit CJ1W-IA201 | <ul style="list-style-type: none"> ● DC Input Unit CJ1W-ID211 CJ1W-ID212 High-speed type ● AC Input Unit CJ1W-IA111 | <ul style="list-style-type: none"> ● DC Input Unit CJ1W-ID231 CJ1W-ID232 CJ1W-ID233 High-speed type | <ul style="list-style-type: none"> ● DC Input Unit CJ1W-ID261 CJ1W-ID262 |
| Output Units | | | |
| <ul style="list-style-type: none"> ● Relay Contact Output Unit (independent commons) CJ1W-OC201 ● Triac Output Unit CJ1W-OA201 ● Transistor Output Units CJ1W-OD201 CJ1W-OD203 CJ1W-OD202 CJ1W-OD204 | <ul style="list-style-type: none"> ● Relay Contact Output Unit CJ1W-OC211 ● Transistor Output Units CJ1W-OD211 CJ1W-OD213 High-speed type CJ1W-OD212 | <ul style="list-style-type: none"> ● Transistor Output Units CJ1W-OD231 CJ1W-OD233 CJ1W-OD234 High-speed type CJ1W-OD232 | <ul style="list-style-type: none"> ● Transistor Output Units CJ1W-OD261 CJ1W-OD263 CJ1W-OD262 |
| I/O Units | | | |
| --- | --- | (16 inputs, 16 outputs) <ul style="list-style-type: none"> ● DC Input/Transistor Output Units CJ1W-MD231 CJ1W-MD233 CJ1W-MD232 | 32 inputs, 32 outputs <ul style="list-style-type: none"> ● DC Input/Transistor Output Units CJ1W-MD261 CJ1W-MD263 32 inputs, 32 outputs <ul style="list-style-type: none"> ● TTL I/O Unit CJ1W-MD563 |
| Other Units | | | |
| --- | <ul style="list-style-type: none"> ● Interrupt Input Unit CJ1W-INT01 ● Quick-response Input Unit CJ1W-IDP01 | --- | <ul style="list-style-type: none"> ● B7A Interface Units (64 inputs) CJ1W-B7A14 (64 outputs) CJ1W-B7A04 (32 inputs, 32 outputs) CJ1W-B7A22 |

| CJ1 Special I/O Units and CPU Bus Units | | | |
|--|---|---|--|
| <ul style="list-style-type: none"> ■ Process I/O Units ● Isolated-type Units with Universal Inputs CJ1W-PH41U CJ1W-AD04U ● Isolated-type Thermocouple Input Units CJ1W-PTS15 CJ1W-PTS51 ● Isolated-type Resistance Thermometer Input Units CJ1W-PTS16 CJ1W-PTS52 ● Isolated-type DC Input Unit CJ1W-PDC15 ■ Analog I/O Units ● Analog Input Units CJ1W-AD042 High-speed type CJ1W-AD081-V1 CJ1W-AD041-V1 ● Analog Output Units CJ1W-DA042V High-speed type CJ1W-DA08V CJ1W-DA08C CJ1W-DA041 CJ1W-DA021 ● Analog I/O Units CJ1W-MAD42 ■ Temperature Control Units CJ1W-TC001, CJ1W-TC002 CJ1W-TC003, CJ1W-TC004 CJ1W-TC101, CJ1W-TC102 CJ1W-TC103, CJ1W-TC104 | <ul style="list-style-type: none"> ■ High-speed Counter Units CJ1W-CT021 ■ Position Control Units CJ1W-NC214 High-speed type CJ1W-NC414 High-speed type CJ1W-NC234 High-speed type CJ1W-NC434 High-speed type CJ1W-NC113 CJ1W-NC213 CJ1W-NC413 CJ1W-NC133 CJ1W-NC233 CJ1W-NC433 ■ Position Control Unit with EtherCAT interface CJ1W-NC281 CJ1W-NC481 CJ1W-NC881 CJ1W-NCF81 CJ1W-NC482 CJ1W-NC882 CJ1W-NCF82 ■ Position Control Unit with MECHATROLINK-II interface CJ1W-NC271 CJ1W-NC471 CJ1W-NCF71 CJ1W-NCF71-MA ■ Motion Control Unit with MECHATROLINK-II interface CJ1W-MCH71 | <ul style="list-style-type: none"> ■ Serial Communications Units CJ1W-SCU22 High-speed type CJ1W-SCU32 High-speed type CJ1W-SCU42 High-speed type CJ1W-SCU21-V1 CJ1W-SCU31-V1 CJ1W-SCU41-V1 ■ EtherNet/IP Unit CJ1W-EIP21 CJ1W-EIP21S ■ Ethernet Unit CJ1W-ETN21 ■ Controller Link Units CJ1W-CLK23 ■ FL-net Unit CJ1W-FLN22 ■ DeviceNet Unit CJ1W-DRM21 ■ CompoNet Master Unit CJ1W-CRM21 ■ CompoBus/S Master Unit CJ1W-SRM21 ■ EtherCAT Slave Unit CJ1W-ECT21 | <ul style="list-style-type: none"> ■ ID Sensor Units CJ1W-V680C11 CJ1W-V680C12 CJ1W-V600C11 CJ1W-V600C12 ■ High-speed Data Storage Unit CJ1W-SPU01-V2 |

Note 1. Microsoft, Visual Basic, Visual C#, Visual Studio and Windows are either registered trademarks or trademarks of Microsoft Corporation in the United States and/or other countries. Microsoft product screen shot(s) reprinted with permission from Microsoft Corporation.
 EtherCAT® is registered trademark and patented technology, licensed by Beckhoff Automation GmbH, Germany.
 EtherNet/IP™, DeviceNet™ and CompoNet™ are trademarks of the ODVA.
 Other company names and product names in this document are the trademarks or registered trademarks of their respective companies.

2. Including models whose production are discontinued.

■ CJ-series CPU Racks

A CJ-series CPU Rack consists of a CPU Unit, Power Supply Unit, Configuration Units (Basic I/O Units, Special I/O Units, and CPU Bus Units), and an End Cover.

CJ2H CPU Units

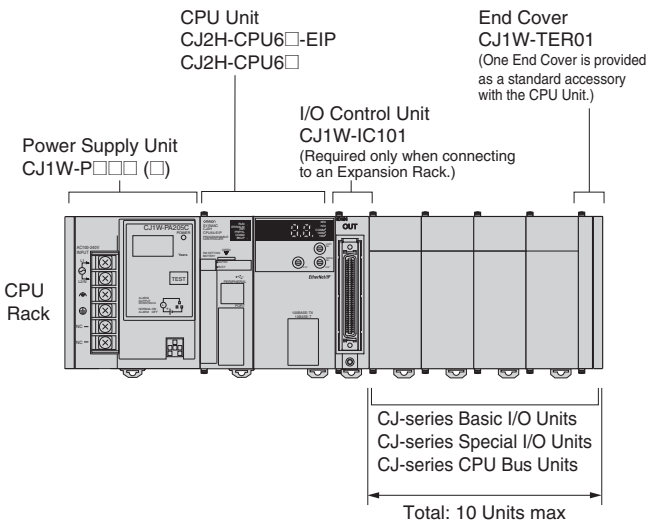

CJ2M CPU Units

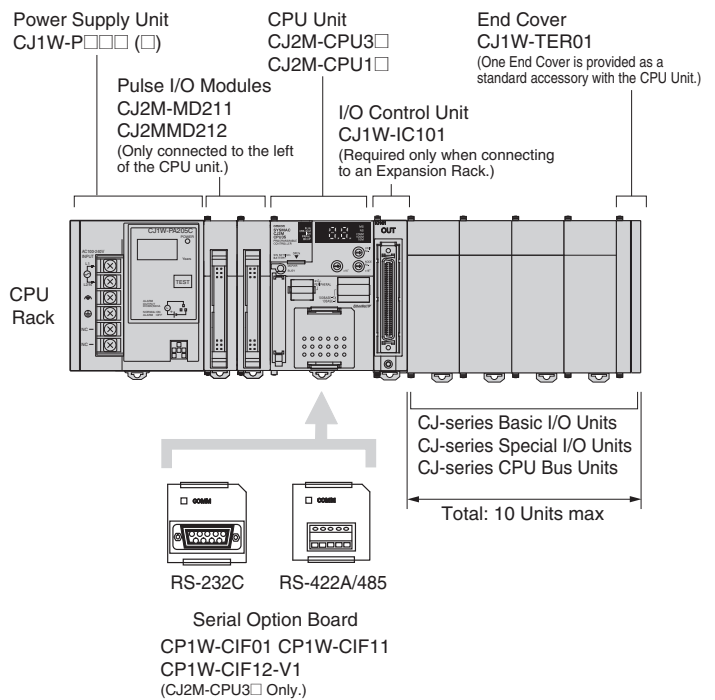

● Required Units

| Rack | Unit name | Required number of Units |
|----------|-------------------------------|--|
| CPU Rack | Power Supply Unit | 1 |
| | CPU Unit | 1 |
| | Pulse I/O Modules | Required only for using Pulse I/O. Up to two Pulse I/O Modules can be connected to a CJ2M CPU Unit. They must be connected immediately to the left of the CPU Unit. |
| | Serial Option Board | One Serial Option Board can be mounted in the CJ2M-CPU3□. |
| | I/O Control Unit | Required only for mounting to an Expansion Rack. Mount the I/O Control Unit immediately to the right of the CPU Unit. |
| | Number of Configuration Units | 10 max. (Same for all models of CPU Unit.) (The number of Basic I/O Units, Special I/O Units, and CPU Bus Units can be varied. The number does not include the I/O Control Unit.) |
| | End Cover | 1 (Included with CPU Unit.) |

● Types of Units

In the CJ Series, Units are classified into the following three types. The number of Racks differs depending on the type.

| Type | Appearance (example) | Description | Unit recognition method | Max. Units mountable per CPU Unit |
|-------------------|----------------------|--|--|--|
| Basic I/O Units | | Units with contact inputs and contact outputs. | Recognized by the CPU Unit according to the position of the Rack and slot. | A maximum of 40 Units can be mounted. |
| Special I/O Units | | Special I/O Units provide more advanced functions than do Basic I/O Units, including I/O other than contact inputs and contact outputs. Examples of Special I/O Units are Analog I/O Units and High-speed Counter Units. They differ from CPU Bus Units (including Network Communications Units) in having a smaller area for exchanging data with the CPU Unit. | Recognized by the CPU Unit according to the unit number (0 to 95) set with the rotary switches on the front panel. | A maximum of 40 Units can be connected. (Multiple unit numbers are allocated per Unit, depending on the model and settings.) |
| CPU Bus Units | | CPU Bus Units exchange data with the CPU Unit via the CPU Bus. Examples of CPU Bus Units are Network Communications Units and Serial Communications Units. They differ from Special I/O Units in having a larger area for exchanging data with the CPU Unit. | Recognized by the CPU Unit according to the unit number (0 to F) set with the rotary switch on the front panel. | A maximum of 16 Units can be mounted. |

■ CJ-series Expansion Racks

A CJ-series Expansion Rack consists of a Power Supply Unit, an I/O Interface Unit, Configuration Units (Basic I/O Units, Special I/O Units, and CPU Bus Units), and an End Cover.

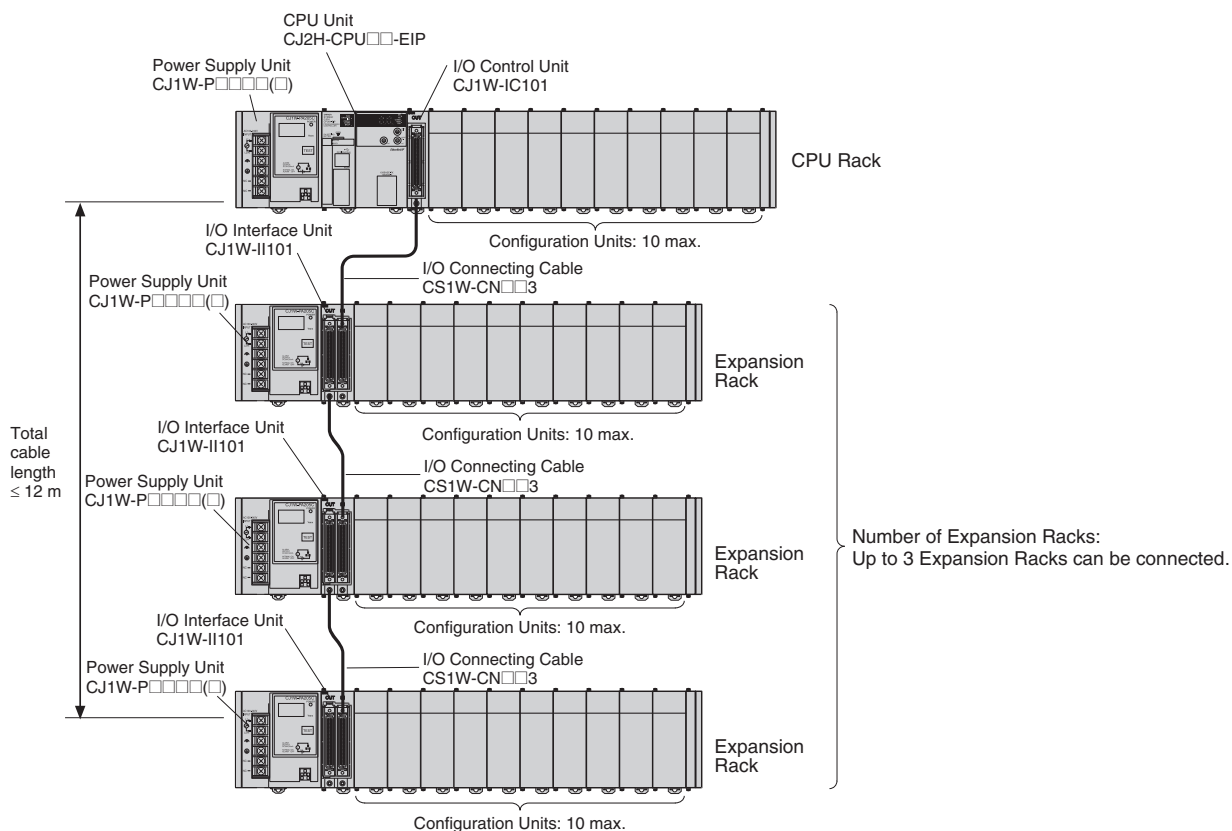

● Required Units

| Rack | Unit name | Required number of Units |
|----------------|-------------------------------|--|
| CPU Rack | I/O Control Unit | One Unit. Required only when an Expansion Rack is used. Mount the I/O Control Unit immediately to the right of the CPU Unit. (See note 1.) |
| Expansion Rack | Power Supply Unit | One Unit |
| | I/O Interface Unit | One Unit. Mount the I/O Interface Unit immediately to the right of the Power Supply Unit. (See note 2.) |
| | Number of Configuration Units | Ten Units max. (The number of Basic I/O Units, Special I/O Units, and CPU Bus Units can be varied. This number does not include the I/O Interface Unit.) |
| | End Cover | One (Included with the I/O Interface Unit.) |

- Note 1.** Mounting the I/O Control Unit in any other location may cause faulty operation.
Note 2. Mounting the I/O Interface Unit in any other location may cause faulty operation.

● Maximum Number of Configuration Units That Can Be Mounted

| CPU Unit | Model | Total Units | No. of Units on CPU Rack | No. of Expansion Racks |
|------------|-------------------|-------------|--------------------------|------------------------|
| CJ2H | CJ2H-CPU68 (-EIP) | 40 | 10 per Rack | 3 Racks x 10 Units |
| | CJ2H-CPU67 (-EIP) | | | |
| | CJ2H-CPU66 (-EIP) | | | |
| | CJ2H-CPU65 (-EIP) | | | |
| | CJ2H-CPU64 (-EIP) | | | |
| CJ2M | CJ2M-CPU35 | 40 | 10 per Rack | 3 Racks x 10 Units |
| | CJ2M-CPU34 | | | |
| | CJ2M-CPU33 | | | |
| | CJ2M-CPU32 | | | |
| | CJ2M-CPU31 | | | |
| | CJ2M-CPU15 | | | |
| | CJ2M-CPU14 | | | |
| | CJ2M-CPU13 | | | |
| | CJ2M-CPU12 | | | |
| CJ2M-CPU11 | | | | |

Note: It may not be possible to mount the maximum number of configuration Units depending on the specific Units that are mounted. Refer to the next page for details.

● Configuration Units

CJ-series Special I/O Units

| Type | Name | Specifications | Model | Number of words allocated (CIO 2000 to CIO 2959) | Number of words allocated (D20000 to D29599) | Unit No. | Number of mountable Units | Current consumption (A) | | Weight |
|---|--|---|---------------|--|--|---|---------------------------|-------------------------|------------|------------|
| | | | | | | | | 5 VDC | 24 VDC | |
| Special I/O Units | General-purpose Universal Analog Input Unit | 4 inputs, fully universal | CJ1W-AD04U | 10 words | 100 words | 0 to 95 | 40 Units | 0.32 | --- | 150 g max. |
| | Analog Input Units | 8 inputs (4 to 20 mA, 1 to 5 V, etc.) | CJ1W-AD081-V1 | 10 words | 100 words | 0 to 95 | 40 Units | 0.42 | --- | 140 g max. |
| | | 4 inputs (4 to 20 mA, 1 to 5 V, etc.) | CJ1W-AD041-V1 | 10 words | 100 words | 0 to 95 | 40 Units | 0.42 | --- | 140 g max. |
| | | 4 inputs (4 to 20 mA, 1 to 5 V, etc.) | CJ1W-AD042 | 10 words | 100 words | 0 to 95 | 40 Units | 0.52 | --- | 150 g max. |
| | Analog Output Units | 4 outputs (1 to 5 V, 4 to 20 mA, etc.) | CJ1W-DA041 | 10 words | 100 words | 0 to 95 | 40 Units | 0.12 | --- | 150 g max. |
| | | 2 outputs (1 to 5 V, 4 to 20 mA, etc.) | CJ1W-DA021 | 10 words | 100 words | 0 to 95 | 40 Units | 0.12 | --- | 150 g max. |
| | | 8 outputs (1 to 5 V, 0 to 10 V, etc.) | CJ1W-DA08V | 10 words | 100 words | 0 to 95 | 40 Units | 0.14 | --- | 150 g max. |
| | | 8 outputs (4 to 20 mA) | CJ1W-DA08C | 10 words | 100 words | 0 to 95 | 40 Units | 0.14 | --- | 150 g max. |
| | | 4 outputs (1 to 5 V, 0 to 10 V, etc.) | CJ1W-DA042V | 10 words | 100 words | 0 to 95 | 40 Units | 0.40 | --- | 150 g max. |
| | Analog I/O Unit | 4 inputs (1 to 5 V, 4 to 20 mA, etc.) 2 outputs (1 to 5 V, 4 to 20 mA, etc.) | CJ1W-MAD42 | 10 words | 100 words | 0 to 95 | 40 Units | 0.58 | --- | 150 g max. |
| | Isolated-type High-resolution Universal Input Unit | 4 inputs, fully universal Resolution: 1/256,000, 1/64,000, 1/16,000 | CJ1W-PH41U | 10 words | 100 words | 0 to 95 | 40 Units | 0.30 | --- | 150 g max. |
| | Isolated-type Thermocouple Input Units | 4 thermocouple inputs | CJ1W-PTS51 | 10 words | 100 words | 0 to 95 | 40 Units | 0.25 | --- | 150 g max. |
| | | 2 thermocouple inputs | CJ1W-PTS15 | 10 words | 100 words | 0 to 95 | 40 Units | 0.18 | --- | 150 g max. |
| | Isolated-type Resistance Thermometer Input Units | 4 resistance thermometer inputs | CJ1W-PTS52 | 10 words | 100 words | 0 to 95 | 40 Units | 0.25 | --- | 150 g max. |
| | | 2 resistance thermometer inputs | CJ1W-PTS16 | 10 words | 100 words | 0 to 95 | 40 Units | 0.18 | --- | 150 g max. |
| | Direct Current Input Unit | DC voltage or DC current, 2 inputs | CJ1W-PDC15 | 10 words | 100 words | 0 to 95 | 40 Units | 0.18 | --- | 150 g max. |
| | Temperature Control Units | 4 control loops, thermocouple inputs, NPN outputs | CJ1W-TC001 | 20 words | 200 words | 0 to 94 (uses words for 2 unit numbers) | 40 Units | 0.25 | --- | 150 g max. |
| | | 4 control loops, thermocouple inputs, PNP outputs | CJ1W-TC002 | 20 words | 200 words | 0 to 94 (uses words for 2 unit numbers) | 40 Units | 0.25 | --- | 150 g max. |
| | | 2 control loops, thermocouple inputs, NPN outputs, heater burnout detection | CJ1W-TC003 | 20 words | 200 words | 0 to 94 (uses words for 2 unit numbers) | 40 Units | 0.25 | --- | 150 g max. |
| | | 2 control loops, thermocouple inputs, PNP outputs, heater burnout detection | CJ1W-TC004 | 20 words | 200 words | 0 to 94 (uses words for 2 unit numbers) | 40 Units | 0.25 | --- | 150 g max. |
| 4 control loops, temperature-resistance thermometer inputs, NPN outputs | | CJ1W-TC101 | 20 words | 200 words | 0 to 94 (uses words for 2 unit numbers) | 40 Units | 0.25 | --- | 150 g max. | |
| 4 control loops, temperature-resistance thermometer inputs, PNP outputs | | CJ1W-TC102 | 20 words | 200 words | 0 to 94 (uses words for 2 unit numbers) | 40 Units | 0.25 | --- | 150 g max. | |
| 2 control loops, temperature-resistance thermometer inputs, NPN outputs, heater burnout detection | | CJ1W-TC103 | 20 words | 200 words | 0 to 94 (uses words for 2 unit numbers) | 40 Units | 0.25 | --- | 150 g max. | |
| 2 control loops, temperature-resistance thermometer inputs, PNP outputs, heater burnout detection | | CJ1W-TC104 | 20 words | 200 words | 0 to 94 (uses words for 2 unit numbers) | 40 Units | 0.25 | --- | 150 g max. | |

Note: Including models whose production are discontinued.

| Type | Name | Specifications | Model | Number of words allocated (CIO 2000 to CIO 2959) | Number of words allocated (D20000 to D29599) | Unit No. | Number of mountable Units | Current consumption (A) | | Weight |
|-------------------------|--|---|----------------------|--|--|---|---------------------------|-------------------------|--------------|------------|
| | | | | | | | | 5 VDC | 24 VDC | |
| Special I/O Units | Position Control Units | 1 axis, pulse output; open collector output | CJ1W-NC113 | 10 words | 100 words | 0 to 95 | 40 Units | 0.25 | --- | 100 g max. |
| | | 2 axes, pulse outputs; open collector outputs | CJ1W-NC213 | 10 words | 100 words | 0 to 95 | 40 Units | 0.25 | --- | 100 g max. |
| | | | CJ1W-NC214 *1, *2 | 18 words *3 | None | 0 to 94 (uses words for 2 unit numbers) | 5 Units/Rack | 0.27 | --- | 170 g max. |
| | | 4 axes, pulse outputs; open collector outputs | CJ1W-NC413 | 20 words | 200 words | 0 to 94 (uses words for 2 unit numbers) | 40 Units | 0.36 | --- | 150 g max. |
| | | | CJ1W-NC414 *1, *2 | 18 words *3 | None | 0 to 94 (uses words for 2 unit numbers) | 5 Units/Rack | 0.31 | --- | 220 g max. |
| | | 1 axis, pulse output; line driver output | CJ1W-NC133 | 10 words | 100 words | 0 to 95 | 40 Units | 0.25 | --- | 100 g max. |
| | | 2 axes, pulse outputs; line driver outputs | CJ1W-NC233 | 10 words | 100 words | 0 to 95 | 40 Units | 0.25 | --- | 100 g max. |
| | | | CJ1W-NC234 *1, *2 | 18 words *3 | None | 0 to 94 (uses words for 2 unit numbers) | 5 Units/Rack | 0.27 | --- | 170 g max. |
| | | 4 axes, pulse outputs; line driver outputs | CJ1W-NC433 | 20 words | 200 words | 0 to 94 (uses words for 2 unit numbers) | 40 Units | 0.36 | --- | 150 g max. |
| | CJ1W-NC434 *1, *2 | | 18 words *3 | None | 0 to 94 (uses words for 2 unit numbers) | 5 Units/Rack | 0.31 | --- | 220 g max. | |
| | Space Unit *4 | CJ1W-SP001 | None | None | --- | --- | --- | --- | 50 g max. | |
| | ID Sensor Units | V600-series single-head type | CJ1W-V600C11 | 10 words | 100 words | 0 to 95 | 40 Units | 0.26 | 0.12 | 120 g max. |
| | | V600-series two-head type | CJ1W-V600C12 | 20 words | 200 words | 0 to 94 (uses words for 2 unit numbers) | 40 Units | 0.32 | 0.24 | 130 g max. |
| | | V680-series single-head type | CJ1W-V680C11 | 10 words | 100 words | 0 to 95 | 40 Units | 0.26 | 0.13 | 120 g max. |
| | | V680-series two-head type | CJ1W-V680C12 | 20 words | 200 words | 0 to 94 (uses words for 2 unit numbers) | 40 Units | 0.32 | 0.26 | 130 g max. |
| High-speed Counter Unit | Number of counter channels: 2, Maximum input frequency: 500 kHz, line driver compatible *5 | CJ1W-CT021 *7 | 40 words | 400 words | 0 to 92 (uses words for 4 unit numbers) | 24 Units | 0.28 | --- | 100 g max. | |
| CompoBus/S Master Units | CompoBus/S remote I/O, 256 bits max. | CJ1W-SRM21 | 10 words or 20 words | None | 0 to 95 or 0 to 94 | 40 Units | 0.15 | --- | 66 g max. *6 | |

Note: Including models whose production are discontinued.

*1. With a CJ2 CPU Unit, up to 10 Configuration Units can be connected in the CPU Rack and in each Expansion Rack. The CJ1W-NC□□4, however, must be counted as two Units. Configure the Units to satisfy the following formula.

Number of CJ1W-NC□□4 Units × 2 + Number of other Units ≤ 10

For example, if five CJ1W-NC□□4 Units are connected to one Rack, no other Units can be connected.

*2. The Units must be mounted on the CPU Rack to use synchronous unit operation.

*3. In addition to the words allocated in the Special I/O Unit Area, up to 144 words are allocated according to the number of axes and functions uses. Word allocations are set using the CX-Programmer.

*4. The Space Unit is for Position Control Units.

*5. If interrupts to the CPU Unit are used, mount the Interrupt Input Unit in one of the following slots on the CPU Rack.

- CJ2H-CPU6□-EIP: Slots 0 to 3
- CJ2H-CPU6□ or CJ2M-CPU□□: Slots 0 to 4

*6. Includes the weight of accessory connectors.

*7. Use Lot No. 030121 or later (Unit Version 1.06) of CJ1W-CT021 when using with CJ2 CPU Units.

| Type | Name | Specifications | Model | Number of words allocated (CIO 2000 to CIO 2959) | Number of words allocated (D20000 to D29599) | Unit No. | Number of mountable Units | Current consumption (A) | | Weight |
|-------------------|----------------------|---|------------|--|--|---|---------------------------|-------------------------|--------|------------|
| | | | | | | | | 5 VDC | 24 VDC | |
| Special I/O Units | CompoNet Master Unit | CompoNet remote I/O | CJ1W-CRM21 | 20 words | None | 0 to 94 (uses words for 2 unit numbers) | 40 Units | 0.40 | --- | 130 g max. |
| | | Communications mode No. 0: 128 inputs/ 128 outputs for Word Slaves | | 40 words | None | 0 to 92 (uses words for 4 unit numbers) | 24 Units | 0.40 | --- | |
| | | Communications mode No. 1: 256 inputs/ 256 outputs for Word Slaves | | 80 words | None | 0 to 88 (uses words for 8 unit numbers) | 12 Units | 0.40 | --- | |
| | | Communications mode No. 2: 512 inputs/ 512 outputs for Word Slaves | | 80 words | None | 0 to 88 (uses words for 8 unit numbers) | 12 Units | 0.40 | --- | |
| | | Communications mode No. 3: 256 inputs/ 256 outputs for Word Slaves and 128 inputs/ 128 outputs for Bit Slaves | | 10 words | Depends on setting | 0 to 95 uses words for 1 unit number) | 40 Units | 0.40 | --- | |
| | | Communications mode No. 8: 1,024 inputs/ 1,024 outputs for Word Slaves and 256 inputs/ 256 outputs for Bit Slaves maximum | | | | | | | | |

CJ-series CPU Bus Units

| Type | Name | Specifications | Model | Number of words allocated (CIO 1500 to CIO 1899) | Unit No. | Maximum number of Units *1 | Current consumption (A) | | Weight |
|--|--|---|---------------|--|-----------------|----------------------------|-------------------------|------------|---------------|
| | | | | | | | 5 VDC | 24 VDC | |
| CPU Bus Units *1 | High-speed Analog Input Unit | 4 inputs: 80 μs/2 inputs, 160 μs/4 inputs | CJ1W-ADG41 *2 | 25 words | 0 to F | 16 Units *3 | 0.65 | --- | 150 g max. |
| | Controller Link Units | Wired data links | CJ1W-CLK23 | 25 words | 0 to F | 8 Units | 0.35 | --- | 110 g max. |
| | Serial Communications Units | One RS-232C port and one RS-422A/485 port | CJ1W-SCU41-V1 | 25 words | 0 to F | 16 Units *3 | 0.38 *4 | --- | 110 g max. |
| | | | CJ1W-SCU21-V1 | | | | 0.28 *4 | | |
| | | | CJ1W-SCU31-V1 | | | | 0.38 | | |
| | | Two RS-232C ports | CJ1W-SCU22 | 16 Units *3 | 0.28 *4 | 160 g max. | | | |
| | | | CJ1W-SCU32 | | 0.4 | | 120 g max. | | |
| | | Two RS-422A/485 ports High-speed models | CJ1W-SCU42 | 0.36 *4 | 140 g max. | | | | |
| | Ethernet Units | 100Base-TX, FINS communications, socket service, FTP server, and mail communications | CJ1W-ETN21 | 25 words | 0 to F | 4 Units | 0.37 | --- | 100 g max. |
| | EtherNet/IP Unit | Tag data links, FINS communications, CIP message communications, FTP server, etc. | CJ1W-EIP21 | 25 words | 0 to F | *5 | 0.41 | --- | 94 g max. |
| | | | CJ1W-EIP21S | | | | 0.65 | | 91 g max. |
| | FL-net Unit | 100Base-TX cyclic transmissions and message transmissions | CJ1W-FLN22 | 25 words | 0 to F | 4 Units | 0.37 | --- | 100 g max. |
| | DeviceNet Unit | DeviceNet remote I/O, 2,048 points; Both Master and Slave functions, Automatic allocation possible without Configurator | CJ1W-DRM21 | 25 words *6 | 0 to F | 16 Units *3 | 0.29 | --- | 118 g max. *7 |
| | Position Control Units with EtherCAT interface *8 | 2 servo axes | CJ1W-NC281 | 25 words | 0 to F | 16 Units *3 | 0.46 | --- | 110 g max. |
| | | 4 servo axes | CJ1W-NC481 | | | | | | |
| | | 8 servo axes | CJ1W-NC881 | | | | | | |
| | | 16 servo axes | CJ1W-NCF81 | | | | | | |
| | | 4 servo axes and 64 I/O slaves | CJ1W-NC482 | | | | | | |
| | | 8 servo axes and 64 I/O slaves | CJ1W-NC882 | | | | | | |
| 16 servo axes and 64 I/O slaves | CJ1W-NCF82 | | | | | | | | |
| EtherCAT Slave Unit | EtherCAT REMORT I/O DATA Input: 400 bytes Output: 400 bytes | CJ1W-ECT21 | 25 words | 0 to F | 16 Units | 0.34 | --- | 97g max. | |
| Position Control Units supporting MECHATROLINK-II communications | MECHATROLINK-II, 16 axes max. | CJ1W-NCF71(-MA) | 25 words | 0 to F | 16 Units *3 | 0.36 | --- | 95 g max. | |
| Motion Control Units supporting MECHATROLINK-II communications | MECHATROLINK-II, Real axes: 30 max., Virtual axes: 2 max., Special motion control language | CJ1W-MCH71 | 25 words | 0 to F | 3 Units/Rack *9 | 0.60 | --- | 210 g max. | |
| SPU Unit (High-speed Storage and Processing Unit) | One CF card type I/II slot (used with OMRON HMC-EF□□□ Memory Card), one Ethernet port | CJ1W-SPU01-V2 *10 | Not used. | 0 to F | 16 Units *3 | 0.56 | --- | 180 g max. | |

Note: Including models whose production are discontinued.

- *1. Some CJ-series CPU Bus Units are allocated words in the CPU Bus Unit Setup Area. The system must be designed so that the number of words allocated in the CPU Bus Unit Setup Area does not exceed its capacity. Refer to 4-6-2 CPU Bus Unit Setup Area in CJ2 CPU Unit Software User's Manual (Cat. No. W473). There may also be limits due to the capacity of the Power Supply Unit that you are using or the maximum number of Units to which memory can be allocated in the CPU Bus Unit Setup Area.
- *2. If interrupts to the CPU Unit are used, mount the Interrupt Input Unit in one of the following slots on the CPU Rack.
 - CJ2H-CPU6□-EIP: Slots 0 to 3
 - CJ2H-CPU6□ or CJ2M-CPU□□: Slots 0 to 4
- *3. Up to 15 Units can be connected for a CJ2H-CPU6□-EIP or CJ2M-CPU3□ CPU Unit.
- *4. Increases by 0.15 A/Unit when an NT-AL001 RS-232C/RS-422A Link Adapter is used. Increases by 0.04 A/Unit when a CJ1W-CIF11 RS-422A Converter is used. Increases by 0.20 A/Unit when an NV3W-M□20L(-V1) Programmable Terminal is used.
- *5. Up to seven Units can be connected for a CJ2H-CPU6□-EIP CPU Unit, up to eight Units can be connected for a CJ2H-CPU6□ CPU Unit, and up to two Units can be connected for a CJ2M CPU Unit.
- *6. Slave I/O are allocated in DeviceNet Area (CIO 3200 to CIO 3799).
- *7. Includes the weight of accessory connectors.
- *8. Only G5-series Servo Drives with Built-in EtherCAT can be connected.
- *9. When mounting to a CJ-series CPU Rack or a CJ-series Expansion Rack, one of these Units uses the space of three Units.
- *10. Use version 2 or higher of the SPU Unit with a CJ2 CPU Unit.

Checking Current Consumption and Power Consumption

After selecting a Power Supply Unit based on considerations such as the power supply voltage, calculate the current and power requirements for each Rack.

Condition 1: Current Requirements

There are two voltage groups for internal power consumption: 5 V and 24 V.

Current consumption at 5 V (internal logic power supply)

Current consumption at 24 V (relay driving power supply)

Condition 2: Power Requirements

For each Rack, the upper limits are determined for the current and power that can be provided to the mounted Units. Design the system so that the total current consumption for all the mounted Units does not exceed the maximum total power or the maximum current supplied for the voltage groups shown in the following tables.

The maximum current and total power supplied for CPU Racks and Expansion Racks according to the Power Supply Unit model are shown below.

Note 1. For CPU Racks, include the CPU Unit current and power consumption in the calculations. When expanding, also include the current and power consumption of the I/O Control Unit in the calculations.

2. For Expansion Racks, include the I/O Interface Unit current and power consumption in the calculations.

| Power Supply Units | Max. current supplied | | Max. total power supplied |
|--------------------|-----------------------|------------------------------|---------------------------|
| | 5 V | 24 V (relay driving current) | |
| CJ1W-PA205C | 5.0 A | 0.8 A | 25 W |
| CJ1W-PA205R | 5.0 A | 0.8 A | 25 W |
| CJ1W-PA202 | 2.8 A | 0.4 A | 14 W |
| CJ1W-PD025 | 5.0 A | 0.8 A | 25 W |
| CJ1W-PD022 | 2.0 A | 0.4 A | 19.6 W |

Conditions 1 and 2 below must be satisfied.

Condition 1: Maximum Current

(1) Total Unit current consumption at 5 V ≤ (A) value

(2) Total Unit current consumption at 24 V ≤ (B) value

Condition 2: Maximum Power

(1) × 5 V + (2) × 24 V ≤ (C) value

Example: Calculating Total Current and Power Consumption

Example: When the Following Units are Mounted to a CJ-series CPU Rack Using a CJ1W-PA205R Power Supply Unit

| Unit type | Model | Quantity | Voltage group | |
|--------------------------------|----------------|----------|---|-------------------------|
| | | | 5 V | 24 V |
| CPU Unit | CJ2H-CPU68-EIP | 1 | 0.820 A | --- |
| I/O Control Unit | CJ1W-IC101 | 1 | 0.020 A | --- |
| Basic I/O Units (Input Units) | CJ1W-ID211 | 2 | 0.080 A | --- |
| | CJ1W-ID231 | 2 | 0.090 A | --- |
| Basic I/O Units (Output Units) | CJ1W-OC201 | 2 | 0.090 A | 0.048 A |
| Special I/O Unit | CJ1W-DA041 | 1 | 0.120 A | --- |
| CPU Bus Unit | CJ1W-CLK23 | 1 | 0.350 A | --- |
| Current consumption | Total | | 0.820 + 0.020 + 0.080 × 2 + 0.090 × 2 + 0.090 × 2 + 0.120 + 0.350 | 0.048 A × 2 |
| | Result | | 1.83 A (≤ 5.0 A) | 0.096 A (≤ 0.8 A) |
| Power consumption | Total | | 1.83 × 5 V = 9.15 W | 0.096 A × 24 V = 2.30 W |
| | Result | | 9.15 + 2.30 = 11.45 W (≤ 25 W) | |

Note: For details on Unit current consumption, refer to *Ordering Information*.

Using the CX-Programmer to Display Current Consumption and Width

CPU Rack and Expansion Rack current consumption and width can be displayed by selecting Current Consumption and Width from the Options Menu in the CJ2 Table Window. If the capacity of the Power Supply Unit is exceeded, it will be displayed in red characters.

Example:

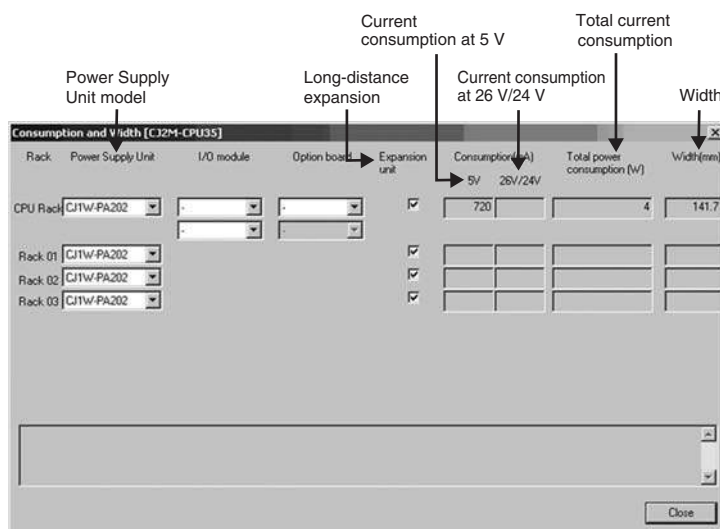

Dimensions

Note: Units are in mm unless specified otherwise.

Product Dimensions

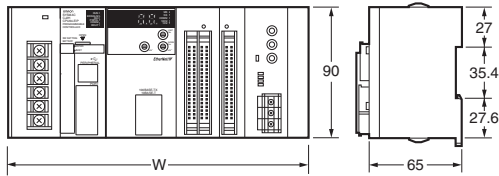

Example Rack Widths using CJ1WPA202 Power Supply Unit (AC, 14 W)

| No. of Units mounted with 31-mm width | Rack width (mm) | | | |
|---------------------------------------|---------------------|-----------------|-----------------|-----------------|
| | With CJ2H-CPU6□-EIP | With CJ2H-CPU6□ | With CJ2M-CPU3□ | With CJ2M-CPU1□ |
| 1 | 170.5 | 139.5 | 152.7 | 121.7 |
| 2 | 201.5 | 170.5 | 183.7 | 152.7 |
| 3 | 232.5 | 201.5 | 214.7 | 183.7 |
| 4 | 263.5 | 232.5 | 245.7 | 214.7 |
| 5 | 294.5 | 263.5 | 276.7 | 245.7 |
| 6 | 325.5 | 294.5 | 307.7 | 276.7 |
| 7 | 356.5 | 325.5 | 338.7 | 307.7 |
| 8 | 387.5 | 356.5 | 369.7 | 338.7 |
| 9 | 418.5 | 387.5 | 400.7 | 369.7 |
| 10 | 449.5 | 418.5 | 431.7 | 400.7 |

Power Supply Units, CPU Units, and End Covers

| Unit/product | Model | Width |
|-------------------|----------------|-------|
| Power Supply Unit | CJ1W-PA205C | 80 |
| | CJ1W-PA205R | 80 |
| | CJ1W-PA202 | 45 |
| | CJ1W-PD025 | 60 |
| | CJ1W-PD022 | 27 |
| CPU Unit | CJ2H-CPU6□-EIP | 79.8 |
| | CJ2H-CPU6□ | 48.8 |
| | CJ2M-CPU3□ | 62 |
| | CJ2M-CPU1□ | 31 |
| End Cover | CJ1W-TER01 | 14.7 |

Power Supply Units

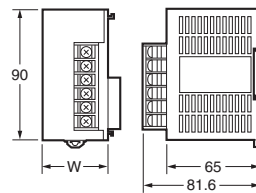

W=27: CJ1W-PD022
 W=45: CJ1W-PA202
 W=80: CJ1W-PA205R
 CJ1W-PA205C
 W=60: CJ1W-PD025

End Cover (included with CPU Units)

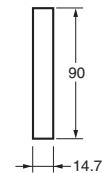

RS-422A Adapter CJ1W-CIF11

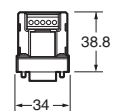

CPU Units CJ2H-CPU6□-EIP

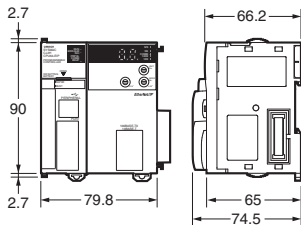

CJ2H-CPU6□

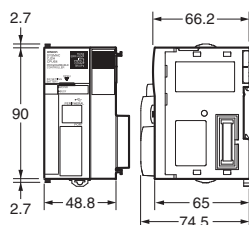

CJ2M-CPU3□

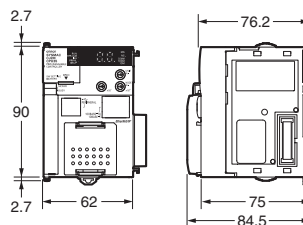

CJ2M-CPU1□

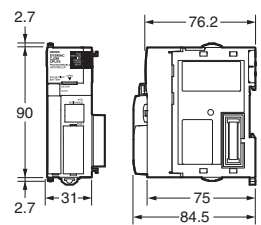

Option Boards (CJ2M-CPU3□ only)

Serial Option Boards CP1W-CIF01

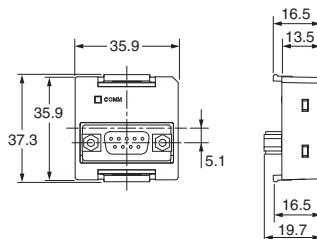

CP1W-CIF11/CP1W-CIF12-V1

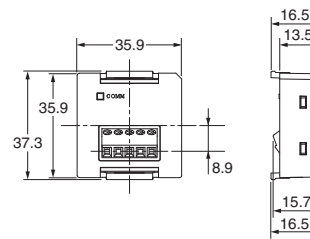

● Units of Width 20 mm

| Unit/product | Model | Width |
|--------------------------|------------------------|-------|
| I/O Control Unit | CJ1W-IC101 | 20 |
| Pulse I/O Modules | CJ2M-MD211/212 | |
| 32-point Basic I/O Units | CJ1W-ID231/232/233 | |
| | CJ1W-OD231/232/233/234 | |
| Space Unit | CJ1W-SP001 | |

● I/O Control Unit

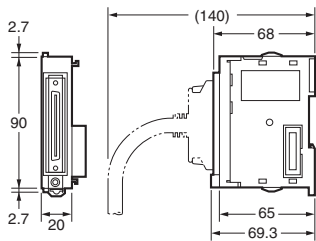

● Pulse I/O Modules (Only CJ2M CPU Unit)

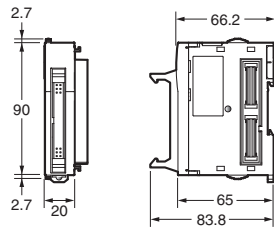

● 32-Point I/O Units (CJ1W-ID223□/OD23□)

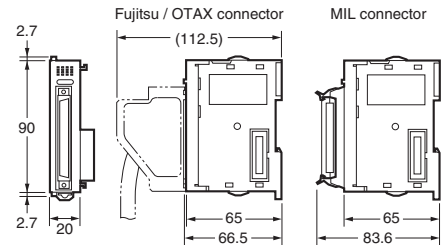

● Units of Width 31 mm

| Unit | Model | Width |
|--|---------------------|-------|
| I/O Interface Unit | CJ1W-II101 | 31 |
| 8/16-point Basic I/O Units | CJ1W-ID201 | |
| | CJ1W-ID211/212 | |
| | CJ1W-IA111/201 | |
| | CJ1W-OD20□ | |
| | CJ1W-OD211/212/213 | |
| | CJ1W-OC201/211 | |
| | CJ1W-OA201 | |
| 32-point Basic I/O Units | CJ1W-MD231 | |
| | CJ1W-MD232/233 | |
| 64-point Basic I/O Units | CJ1W-ID261 | |
| | CJ1W-OD261 | |
| | CJ1W-MD261 | |
| | CJ1W-ID262 | |
| | CJ1W-OD262/263 | |
| Interrupt Input Unit | CJ1W-MD263 | |
| | CJ1W-MD563 | |
| | CJ1W-MD563 | |
| Quick-response Input Unit | CJ1W-MD563 | |
| Analog I/O Units | CJ1W-INT01 | |
| | CJ1W-IDP01 | |
| | CJ1W-AD□□□□ (-V1) | |
| Process Input Units | CJ1W-DA□□□□ (□) | |
| | CJ1W-MAD42 | |
| | CJ1W-AD04U | |
| Temperature Control Units | CJ1W-AD04U | |
| | CJ1W-PTS51/52/15/16 | |
| | CJ1W-PDC15 | |
| | CJ1W-PDC15 | |
| Position Control Units | CJ1W-TC□□□□ | |
| | CJ1W-NC113/133 | |
| | CJ1W-NC213/233 | |
| Position Control Unit with EtherCAT interface | CJ1W-NC413/433 | |
| | CJ1W-NC281 | |
| | CJ1W-NC481 | |
| | CJ1W-NC881 | |
| | CJ1W-NCF81 | |
| | CJ1W-NC482 | |
| | CJ1W-NC882 | |
| CJ1W-NCF82 | | |
| EtherCAT Slave Unit | CJ1W-ECT21 | |
| Position Control Unit with MECHATROLINK-II interface | CJ1W-NCF71 | |
| High-speed Counter Unit | CJ1W-CT021 | |
| ID Sensor Units | CJ1W-V680C11 | |
| | CJ1W-V680C12 | |
| | CJ1W-V600C11 | |
| | CJ1W-V600C12 | |

| Unit | Model | Width |
|-----------------------------|-------------|-------|
| Controller Link Units | CJ1W-CLK23 | 31 |
| Serial Communications Units | CJ1W-SCU22 | |
| | CJ1W-SCU32 | |
| | CJ1W-SCU42 | |
| EtherNet/IP Unit | CJ1W-EIP21 | |
| Ethernet Unit | CJ1W-EIP21S | |
| Ethernet Unit | CJ1W-ETN21 | |
| DeviceNet Unit | CJ1W-DRM21 | |
| CompoNet Master Unit | CJ1W-DRM21 | |
| FL-net Unit | CJ1W-FLN22 | |

● I/O Interface Unit

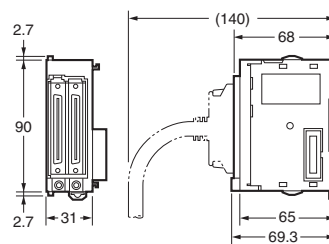

● 8/16-point Basic I/O Units, Interrupt Input Unit, and High-speed Input Unit

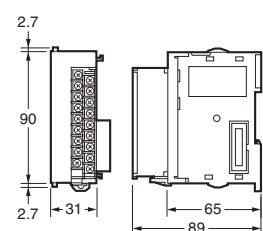

● 64-point Basic I/O Units and 32-point Basic I/O Units (CJ1W-MD23□)

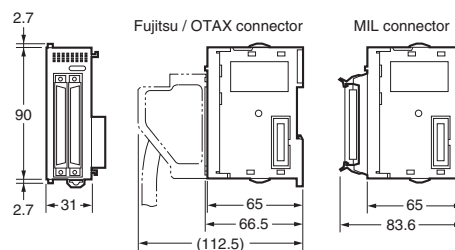

● Special I/O Units and CPU Bus Units

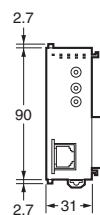

● Units of Width 51 mm

| Unit | Model | Width |
|---|----------------|-------|
| SPU Unit (High-speed Data Storage Unit) | CJ1W-SPU01-V2 | 51 |
| Position Control Units (High-speed type) | CJ1W-NC214/234 | |

● SPU Unit (High-speed Data Storage Unit)
CJ1W-SPU01-V2

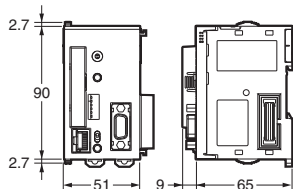

● Unit of Width 62 mm

| Unit | Model | Width |
|---|----------------|-------|
| Position Control Units (High-speed type) | CJ1W-NC414/434 | 62 |

● Position Control Unit (High-speed model)
CJ1W-NC414/434

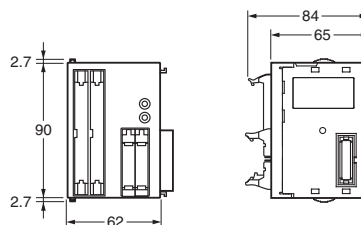

■ Mounting Dimensions

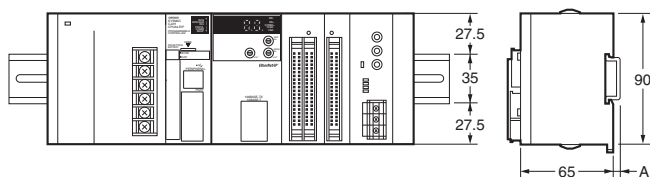

| DIN Track model number | A |
|------------------------|--------|
| PFP-100N2 | 16 mm |
| PFP-100N | 7.3 mm |
| FPP-50N | 7.3 mm |

■ Mounting Height

The mounting height of CJ-series CPU Racks and Expansion Racks is from 81.6 to 89.0 mm depending on the Units that are mounted.

Additional height is required to connect Programming Devices (e.g., CX-Programmer) and Cables. Be sure to allow sufficient mounting height.

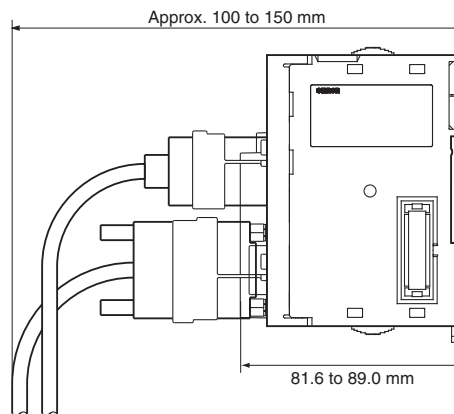

Note: Consider the following points when expanding the configuration:
The total length of I/O Connecting Cable must not exceed 12 m.
I/O Connecting Cables require the bending radius indicated below.

● Expansion Cable

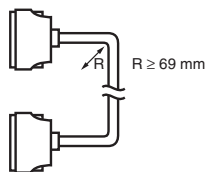

Note: Outer diameter of cable: 8.6 mm.

General Specifications

| Item | CJ2H- | | | | | CJ2M- | |
|---------------------------------|--|--|--------------|--------------|--------------|-----------------------|-----------------------|
| | CPU64 (-EIP) | CPU65 (-EIP) | CPU66 (-EIP) | CPU67 (-EIP) | CPU68 (-EIP) | CPU1□ | CPU3□ |
| Enclosure | Mounted in a panel | | | | | | |
| Grounding | Less than 100 Ω | | | | | | |
| CPU Unit Dimensions (H × D × W) | CJ2H-CPU6□-EIP : 90 mm × 65 mm × 80 mm CJ2H-CPU6□ : 90 mm × 65 mm × 49 mm | | | | | 90 mm × 75 mm × 31 mm | 90 mm × 75 mm × 62 mm |
| Weight *1 | CJ2H-CPU6□-EIP : 280 g or less CJ2H-CPU6□ : 190 g or less | | | | | 130 g or less | 190 g or less *2 |
| Current Consumption | CJ2H-CPU6□-EIP : 5 VDC, 0.82 A CJ2H-CPU6□ : 5 VDC, 0.42 A | | | | | 5 VDC, 0.5 A | 5 VDC, 0.7 A |
| Operation Environment | Ambient Operating Temperature | 0 to 55°C | | | | | |
| | Ambient Operating Humidity | 10% to 90% (with no condensation) | | | | | |
| | Atmosphere | Must be free from corrosive gases. | | | | | |
| | Ambient Storage Temperature | -20 to 70°C (excluding battery) | | | | | |
| | Altitude | 2,000 m or less | | | | | |
| | Pollution Degree | 2 or less: Meets IEC 61010-2-201. | | | | | |
| | Noise Immunity | 2 kV on power supply line (Conforms to IEC 61000-4-4.) | | | | | |
| | Overvoltage Category | Category II: Meets IEC 61010-2-201. | | | | | |
| | EMC Immunity Level | Zone B | | | | | |
| | Vibration Resistance | Conforms to IEC60068-2-6. 5 to 8.4 Hz with 3.5-mm amplitude, 8.4 to 150 Hz Acceleration of 9.8 m/s ² for 100 min in X, Y, and Z directions (10 sweeps of 10 min each = 100 min total) | | | | | |
| Shock Resistance | Conforms to IEC60068-2-27. 147 m/s ² , 3 times in X, Y, and Z directions (100 m/s ² for Relay Output Units) | | | | | | |
| Battery | Life | 5 years at 25°C | | | | | |
| | Weight | Approx. 10 g | | | | | |
| | Model | CJ1W-BAT01 | | | | | |
| Applicable Standards | Conforms to cULus, NK, LR and EC Directives. | | | | | | |

*1. Includes the weight of end covers and battery.

*2. Without a Serial Option Board.

Performance Specifications

| Item | | CJ2H- | | | | | CJ2M- | | | | | |
|-------------------------------------|---|---|--|----------------------|----------------------|---|---|--|---------------------|--------------|--------------|--|
| | | CPU64 (-EIP) | CPU65 (-EIP) | CPU66 (-EIP) | CPU67 (-EIP) | CPU68 (-EIP) | CPU 11/31 | CPU 12/32 | CPU 13/33 | CPU 14/34 | CPU 15/35 | |
| User Memory | | 50K steps | 100K steps | 150K steps | 250K steps | 400K steps | 5K steps | 10K steps | 20K steps | 30K steps | 60K steps | |
| I/O Bits | | 2,560 bits | | | | | | | | | | |
| Processing Speed | Overhead Processing Time *1 | Normal Mode: CJ2H-CPU6□-EIP : 200 μs CJ2H-CPU6□ : 100 μs | | | | | Normal Mode: CJ2M-CPU3□ : 270 μs CJ2M-CPU1□ : 160 μs | | | | | |
| | Execution Time | Basic Instructions: 0.016 μs min.; Special Instructions: 0.048 μs min. | | | | | Basic Instructions: 0.04 μs min.; Special Instructions: 0.06 μs min. | | | | | |
| | Interrupts | I/O Interrupts and External Interrupts | Interrupt task startup time: 17 μs *2 or 26 μs (30 μs for unit version 1.0) Return times to cyclic tasks: 8 μs *2 or 11 μs (15 μs for unit version 1.0) | | | | | Interrupt task startup time: 31 μs Return times to cyclic tasks: 10 μs | | | | |
| | | Scheduled Interrupts | Minimum time interval: 0.2 ms *2 (set in 0.1-ms increments) Interrupt task startup time: 13 μs *2 or 22 μs (27 μs for unit version 1.0) Return times to cyclic tasks: 8 μs *2 or 11 μs (15 μs for unit version 1.0) | | | | | Minimum time interval: 0.4 ms (set in 0.1-ms increments) Interrupt task startup time: 30 μs Return time to cyclic task: 11 μs | | | | |
| Maximum Number of Connectable Units | | Total per CPU Rack or Expansion Rack: 10 Units max.; Total per PLC: 40 Units max. | | | | | | | | | | |
| | Basic I/O Units | No limit However, a maximum of two CJ1W-INT01 Interrupt Input Units can be mounted. | | | | | | | | | | |
| | Special I/O Units | Units for up to 96 unit numbers can be mounted. (Unit numbers run from 0 to 95. Units are allocated between 1 and 8 unit numbers.) | | | | | | | | | | |
| | CPU Bus Units | CJ2M-CPU3□: 15 Units max. CJ2M-CPU1□: 16 Units max. | | | | | | | | | | |
| | Pulse I/O Modules | 2 Units max. *3 | | | | | | | | | | |
| | Slots for which interrupts can be used | Slots 0 to 4 on CPU Rack | | | | | | | | | | |
| Maximum Number of Expansion Racks | | 3 max. | | | | | | | | | | |
| CIO Area | I/O Area | 2,560 bits (160 words): Words CIO 0000 to CIO 0159 | | | | | | | | | | |
| | Link Area | 3,200 bits (200 words): Words CIO 1000 to CIO 1199 | | | | | | | | | | |
| | Synchronous Data Refresh Area | 1,536 bits (96 words): Words CIO 1200 to CIO 1295 | | | | | | | | | --- | |
| | CPU Bus Unit Area | 6,400 bits (400 words): Words CIO 1500 to CIO 1899 | | | | | | | | | | |
| | Special I/O Unit Area | 15,360 bits (960 words): Words CIO 2000 to CIO 2959 | | | | | | | | | | |
| | Pulse I/O Area | --- | | | | | 20 inputs, 12 outputs (CIO 2960 to CIO 2963) *3 | | | | | |
| | Serial PLC Link Words | --- | | | | | 1,440 bits (90 words): Words CIO 3100 to CIO 3189 | | | | | |
| | DeviceNet Area | 9,600 bits (600 words): Words CIO 3200 to CIO 3799 | | | | | | | | | | |
| | Internal I/O Area | 3,200 bits (200 words): Words CIO 1300 to CIO 1499 (Cannot be used for external I/O.) 37,504 bits (2,344 words): Words CIO 3800 to CIO 6143 (Cannot be used for external I/O.) | | | | | | | | | | |
| Work Area | 8,192 bits (512 words): Words W000 to W511 (Cannot be used for external I/O.) | | | | | | | | | | | |
| Holding Area | 8,192 bits (512 words): Words H000 to H511 Bits in this area maintain their ON/OFF status when PLC is turned OFF or operating mode is changed. Words H512 to H1535: These words can be used only for function blocks. They can be used only for function block instances (i.e., they are allocated only for internal variables in function blocks). | | | | | | | | | | | |
| Auxiliary Area | Read-only: 31,744 bits (1,984 words) • 7,168 bits (448 words): Words A0 to A447 • 24,576 bits (1,536 words): Words A10000 to A11535 *4 Read/write: 16,384 bits (1,024 words) in words A448 to A1471 *4 | | | | | | | | | | | |
| Temporary Area | 16 bits: TR0 to TR15 | | | | | | | | | | | |
| Timer Area | 4,096 timer numbers (T0000 to T4095 (separate from counters)) | | | | | | | | | | | |
| Counter Area | 4,096 counter numbers (C0000 to C4095 (separate from timers)) | | | | | | | | | | | |
| DM Area | 32k words *5 DM Area words for Special I/O Units: D20000 to D29599 (100 words × 96 Units) DM Area words for CPU Bus Units: D30000 to D31599 (100 words × 16 Units) | | | | | | | | | | | |
| EM Area | 32k words/bank × 25 banks max.: E00_00000 to E18_32767 max. *5, *6 | | | | | 32k words/bank × 4 banks max.: E00_00000 to E3_32767 max. *5 | | | | | | |
| | 32K words × 4 banks | 32K words × 4 banks | 32K words × 10 banks | 32K words × 15 banks | 32K words × 25 banks | 32K words × 1 bank | | | 32K words × 4 banks | | | |

- *1. The following times are added if EtherNet/IP data tag links are used for the CJ2H-CPU6□-EIP.
Normal operation: 100 μs + Number of transfer words x 0.33 μs
High-speed interrupt enabled: 100 μs + Number of transfer words x 0.87 μs
The following time must be added when using EtherNet/IP tag data links for the CJ2M-CPU3□.
100 μs + (No. of words transferred x 1.8 μs)
The following time must be added when using Pulse I/O Modules with a CJ2M CPU Unit: 10 μs x Number of Pulse I/O Modules.
- *2. This applies when High-speed interrupt function is used.
- *3. Supported only by CJ2M CPU Units with unit version 2.0 or later. A Pulse I/O Module must be mounted.
- *4. A960 to A1471 and A10000 to A11535 cannot be accessed by CPU Bus Units, Special I/O Units, PTs, and Support Software that do not specifically support the CJ2 CPU Units.
- *5. Bits in the EM Area can be addressed either by bit or by word. These bits cannot be addressed by CPU Bus Units, Special I/O Units, PTs, and Support Software that do not specifically support the CJ2 CPU Units.
- *6. EM banks D to 18 cannot be accessed by CPU Bus Units, Special I/O Units, PTs, and Support Software that do not specifically support the CJ2 CPU Units.

| Item | | CJ2H- | | | | | CJ2M- | | | | |
|--|---|--|------------------|------------------|------------------|--------------------|------------|-----------|-----------|------------------|-----------|
| | | CPU64 (-EIP) | CPU65 (-EIP) | CPU66 (-EIP) | CPU67 (-EIP) | CPU68 (-EIP) | CPU 11/31 | CPU 12/32 | CPU 13/33 | CPU 14/34 | CPU 15/35 |
| Banks for which bits can be force-set/reset *7 | Using EM Area force-setting/resetting | Banks 0 to 3 hex | Banks 0 to 3 hex | Banks 0 to 9 hex | Banks 0 to E hex | Banks 0 to 18 hex | Bank 0 hex | | | Banks 0 to 3 hex | |
| | Using automatic address allocation specifications | Bank 3 hex | Bank 3 hex | Banks 6 to 9 hex | Banks 7 to E hex | Banks 11 to 18 hex | --- | | | | |
| Index Registers | | IR0 to IR15 These are special registers for storing PLC memory addresses for indirect addressing. (Index Registers can be set so that they are unique in each task or so that they are shared by all tasks.) | | | | | | | | | |
| Cyclic Task Flag Area | | 128 flags | | | | | | | | | |
| Memory Card | | 128 MB, 256 MB, or 512 MB | | | | | | | | | |
| Operating Modes | | PROGRAM Mode: Programs are not executed. Preparations can be executed prior to program execution in this mode. MONITOR Mode: Programs are executed, and some operations, such as online editing, and changes to present values in I/O memory, are enabled in this mode. RUN Mode: Programs are executed. This is the normal operating mode. | | | | | | | | | |
| Execution Mode | | Normal Mode | | | | | | | | | |
| Programming Languages | | Ladder Logic (LD), Sequential Function Charts (SFC), Structured Text (ST), and Instruction Lists (IL) | | | | | | | | | |
| Function Blocks | Maximum number of definitions | 2,048 | | | | | 256 | | | 2,048 | |
| | Maximum number of instances | 2,048 | | | | | 256 | | | 2,048 | |
| FB Program Area | | --- | | | | | 20K steps | | | | |
| Tasks | Type of Tasks | Cyclic tasks Interrupt tasks (Power OFF interrupt tasks, scheduled interrupt tasks, I/O interrupt tasks, and external interrupt tasks, and input interrupt tasks *3) | | | | | | | | | |
| | Number of Tasks | Cyclic tasks: 128 Interrupt tasks: 256 (Interrupt tasks can be defined as cyclic tasks to create extra cyclic tasks. Therefore, the total number of cyclic tasks is actually 384 max.) | | | | | | | | | |
| Symbols (Variables) | Type of Symbols | <ul style="list-style-type: none"> Local symbols: Can be used only within a single task in the PLC. Global symbols: Can be used in all tasks in the PLC. Network symbols (tags) *8: I/O memory in the CPU Unit can be externally accessed using symbols, depending on parameter settings. | | | | | | | | | |
| | Data Type of Symbols | <ul style="list-style-type: none"> BOOL (bit) UINT (one-word unsigned binary) UDINT (two-word unsigned binary) ULINT (four-word unsigned binary) INT (one-word signed binary) DINT (two-word signed binary) LINT (four-word signed binary) UINT BCD (one-word unsigned BCD) *9 UDINT BCD (two-word unsigned BCD) *9 ULINT BCD (four-word unsigned BCD) *9 REAL (two-word floating-point) LREAL (four-word floating-point) CHANNEL (word) *9 NUMBER (constant or number) *9 WORD (one-word hexadecimal) DWORD (two-word hexadecimal) LWORD (four-word hexadecimal) STRING (1 to 255 ASCII characters) TIMER *10 COUNTER *10 user-defined data types (delta structures) *11 | | | | | | | | | |
| | Maximum Size of Symbol | 32k words | | | | | | | | | |
| | Array Symbols (Array Variables) | One-dimensional arrays | | | | | | | | | |
| | Number of Array Elements | 32,000 elements max. | | | | | | | | | |
| | Number of Registrable Network Symbols (Tags) *8 | 20,000 max. | | | | | 2,000 max. | | | | |
| | Length of Network Symbol (Tag) Name *8 | 255 bytes max. | | | | | | | | | |
| | Encoding of Network Symbols (Tags) *8 | UTF-8 | | | | | | | | | |

*7. With CJ2H CPU Units with unit version 1.2 or later, force-setting/resetting bits in the EM Area is possible either for banks that have been specified for automatic address assignment or for banks specified for the EM Area force-set/reset function. With CJ2M CPU Units, force-setting/resetting bits in the EM Area is possible only for banks specified for the EM Area force-set/reset function.

*8. Supported only by the CJ2H-CPU6□-EIP and CJ2M-CPU3□.

*9. This data type cannot be used in Function blocks.

*10. This data type can be used only in Function blocks.

*11. Supported only when CX-Programmer version 9.0 or later is used.

| Item | | CJ2H- | | | | | CJ2M- | | | | | |
|------------------------------|--|---|--|-----------------|-----------------|-----------------|--|--|--------------|--------------|--------------|--|
| | | CPU64 (-EIP) | CPU65 (-EIP) | CPU66 (-EIP) | CPU67 (-EIP) | CPU68 (-EIP) | CPU 11/31 | CPU 12/32 | CPU 13/33 | CPU 14/34 | CPU 15/35 | |
| Data Tracing | Memory Capacity | 8,000 words | | 16,000 words | 32,000 words | | 8,000 words | | | | | |
| | | The EM Area can be specified from the CX-Programmer to use up to 32K words multiplied by the number of banks supported by the CPU Unit model. | | | | | | | | | | |
| | Number of Samplings | Bits = 31, one-word data =16, two-word data = 8, four-word data = 4 | | | | | | | | | | |
| | Sampling Cycle | 1 to 2,550 ms (Unit: 1 ms) | | | | | | | | | | |
| | Trigger Conditions | ON/OFF of specified bit Data comparison of specified word Data size: 1 word, 2 words, 4 words Comparison Method: Equals (=), Greater Than (>), Greater Than or Equals (≥), Less Than (<), Less Than or Equals (≤), Not Equal (≠) | | | | | | | | | | |
| | Delay Value | -32,768 to +32,767 ms | | | | | | | | | | |
| File Memory | | Memory Card (128, 256, or 512 Mbytes) (Use the Memory Cards provided by OMRON.) EM file memory (Part of the EM Area can be converted for use as file memory.) | | | | | | | | | | |
| Source/ Comment Memory | Function block program memory, comment file, program index file, symbol tables | Capacity: 3.5 Mbytes | | | | | Capacity: 1 Mbytes | | | | | |
| Comm unicati ons | Logical Ports for Communications | Logical Ports | 8 ports (Used for SEND, RECV, CMND, PMCR, TXDU, and RXDU instructions.) | | | | | | | | | |
| | | Extended Logical Ports | 64 ports (Used for SEND2, RECV2, CMND2, and PMCR2 instructions.) | | | | | | | | | |
| | CIP Communications Specification | Class 3 (Connection Type) | Number of connections: 128 | | | | | | | | | |
| | | UCMM (Non-connection Type) | Maximum number of clients that can communicate at the same time: 32 Maximum number of servers that can communicate at the same time: 32 | | | | Maximum number of clients that can communicate at the same time: 16 Maximum number of servers that can communicate at the same time: 16 | | | | | |
| | Peripheral (USB) Port | | USB 2.0-compliant B-type connector | | | | | | | | | |
| | | Baud Rate | 12 Mbps max. | | | | | | | | | |
| | | Transmission Distance | 5 m max. | | | | | | | | | |
| | Serial Port | | Interface: Conforms to EIA RS-232C. | | | | | <ul style="list-style-type: none"> • CJ2M-CPU1□ interface: Conforms to EIA RS-232C. • CJ2M-CPU3□: No serial ports with default system One of the following Serial Option Boards can be mounted. • CP1W-CIF01 RS-232C Option Board • CP1W-CIF11 RS-422A/485 Option Board (not isolated, max. transmission distance: 50 m) • CP1W-CIF12-V1 RS-422A/485 Option Board (isolated, max. transmission distance: 500 m) | | | | |
| | | Communications Method | Half-duplex | | | | | | | | | |
| | | Synchronization Method | Start-stop | | | | | | | | | |
| | Baud Rate | 0.3, 0.6, 1.2, 2.4, 4.8, 9.6, 19.2, 38.4, 57.6, or 115.2 (kbps) | | | | | | | | | | |
| | Transmission Distance | 15 m max. | | | | | | | | | | |

| Item | | CJ2H- | | | | | CJ2M- | | | | | |
|------------------------------|--|--|---|--------------|--------------|--|-----------|---|-----------|-----------|-----------|--|
| | | CPU64 (-EIP) | CPU65 (-EIP) | CPU66 (-EIP) | CPU67 (-EIP) | CPU68 (-EIP) | CPU 11/31 | CPU 12/32 | CPU 13/33 | CPU 14/34 | CPU 15/35 | |
| Communications | EtherNet/IP Port *12 | --- | | | | | | | | | | |
| | Transmission Specifications | Media Access Method | CSMA/CD | | | | | | | | | |
| | | Modulation | Baseband | | | | | | | | | |
| | | Transmission Paths | Star | | | | | | | | | |
| | | Baud Rate | 100 Mbps (100Base-TX) | | | | | | | | | |
| | | Transmission Media | Shielded twisted-pair (STP) cable; Categories: 5, 5e | | | | | | | | | |
| | | Transmission Distance | 100 m (between ethernet switch and node) | | | | | | | | | |
| | | Number of Cascade Connections | No restrictions if ethernet switch is used. | | | | | | | | | |
| | Communications Specifications | CIP Communications: Tag Data Links | --- | | | | | | | | | |
| | | Number of Connections | 256 | | | | | 32 | | | | |
| | | Packet Interval (Refresh period) | 0.5 to 10,000 ms (Unit: 0.5 ms) Can be set for each connection. (Data will be refreshed at the set interval, regardless of the number of nodes.) | | | | | 1 to 10,000 ms (in 0.5-ms increments) Can be set for each connection. (Data will be refreshed at the set interval, regardless of the number of nodes.) | | | | |
| | | Maximum allowed communications bandwidth per Unit | 6,000 to 12,000 packets per second *13 *14 | | | | | 3,000 packets per second *13 | | | | |
| | | Number of Tag Sets | 256 | | | | | 32 | | | | |
| | | Type of Tags | CIO, DM, EM, HR, WR, and network symbols | | | | | | | | | |
| | | Number of Tags per Connection | 8 (Seven tags if PLC status is included in the segment.) | | | | | | | | | |
| | | Maximum Link Data Size per Node (total size of all tags) | 184,832 words | | | | | 640 words | | | | |
| | | Maximum Data Size per Connection | 252 or 722 words *15 (Data is synchronized within each connection.) | | | | | 640 words *16 (Data is synchronized within each connection.) | | | | |
| | | Number of Registrable Tag Set | 256 (1 connection = 1 segment) | | | | | 32 (1 connection = 1 segment) | | | | |
| | | Maximum Tag Set Size | 722 words (One word is used when PLC status is included in the segment.) | | | | | 640 words *16 (One word is used when PLC status is included in the segment.) | | | | |
| | | Maximum Number of Tags Refreshable in a Single Cycle of CPU Unit *17 | Output/send (CPU Unit to EtherNet/IP): 256 Input/receive (EtherNet/IP to CPU Unit): 256 | | | | | Output/send (CPU Unit to EtherNet/IP): 32 Input/receive (EtherNet/IP to CPU Unit): 32 | | | | |
| | | Data Size Refreshable in a Single Cycle of CPU Unit *17 | Output/send (CPU to EtherNet/IP): 6,432 words Input/receive (EtherNet/IP to CPU): 6,432 words | | | | | Output/send (CPU Unit to EtherNet/IP): 640 words Input/receive (EtherNet/IP to CPU Unit): 640 words | | | | |
| | | Change of Tag Data Link Parameter Settings during Operation | OK *18 | | | | | | | | | |
| | | Multi-cast Packet Filter *19 | OK | | | | | | | | | |
| | | CIP Communications: Explicit Messages | CIP Communications: Explicit Messages | --- | | | | | | | | |
| Class 3 (Connection Type) | | | Number of connections: 128 | | | | | | | | | |
| UCMM (Non-connection Type) | Maximum number of clients that can communicate at the same time: 32 Maximum number of servers that can communicate at the same time: 32 | | | | | Maximum number of clients that can communicate at the same time: 16 Maximum number of servers that can communicate at the same time: 16 | | | | | | |
| CIP Routing | OK (CIP routing is enabled for the following remote Units: CJ1W-EIP21, CJ1W-EIP21S, CJ2H-CPU6□-EIP, CJ2M-CPU3□, CS1W-EIP21 and CS1W-EIP21S.) | | | | | | | | | | | |
| FINS Communications | --- | | | | | | | | | | | |
| FINS/UDP | FINS/UDP | OK | | | | | | | | | | |
| | FINS/TCP | 16 connections max. | | | | | | | | | | |
| EtherNet/IP Conformance Test | Conforms to A5. | | | | | | | | | | | |
| EtherNet/IP Interface | 10Base-T/100Base-TX Auto Negotiation/Fixed Setting | | | | | | | | | | | |

- *12. The EtherNet/IP port is built into the CJ2H-CPU6□-EIP and CJ2M-CPU3□ only.
- *13. "Packets per second" is the number of communications packets that can be processed per second.
- *14. When using the EtherNet/IP Unit with version 3.0 or later. When using the EtherNet/IP Unit with version 2.1 or earlier, the maximum allowed communications bandwidth per Unit is 6,000 pps. When using the EtherNet/IP Unit with version 3.0 or later, the Network Configurator with version 3.57 or higher is required.
- *15. Large Forward Open (CIP optional specification) must be supported in order for 505 to 1,444 bytes to be used as the data size. Application is supported between CS/CJ-series PLCs. When connecting to devices from other manufacturers, make sure that the devices support the Large Forward Open specification.
- *16. Unit version 2.0 of built-in EtherNet/IP section: 20 words.
- *17. If the maximum number is exceeded, refreshing will require more than one CPU Unit cycle.
- *18. When changing parameters, however, the EtherNet/IP port where the change is made will be restarted. In addition, a timeout will temporarily occur at the other node that was communicating with that port, and it will then recover automatically.
- *19. The EtherNet/IP port supports an IGMP client, so unnecessary multicast packets are filtered by using an ethernet switch that supports IGMP snooping.

Function Specifications

| Functions | | Description | |
|-----------------------|--|--|---|
| Cycle Time Management | Minimum Cycle Time | A minimum cycle time can be set. (0.2 to 32,000 ms; Unit: 0.1 ms) The minimum cycle time setting can be changed in MONITOR mode. *1 | |
| | Cycle Time Monitoring | The cycle time is monitored. (0.01 to 40,000 ms; Unit: 0.01 ms) | |
| | Background Processing | Instructions with long execution times can be executed over multiple cycles to prevent fluctuations in the cycle time. | |
| Unit (I/O) Management | Basic I/O Units, Special I/O Units, and CPU Bus Units | I/O Refreshing | Cyclic Refreshing Cyclic refreshing of Basic I/O Units, Special I/O Units, and CPU Bus Units |
| | | | Immediate Refreshing I/O refreshing by immediate refreshing instructions |
| | | | Refreshing by IORF I/O refreshing by IORF instruction |
| | | Unit Recognition at Startup | The number of units recognized when the power is turned ON is displayed. |
| | Basic I/O Units | Input Response Time Setting | The input response times can be set for Basic I/O Units. The response time can be increased to reduce the effects of chattering and noise at input contacts. The response time can be decreased to enable detecting shorter input pulses. |
| | | Load OFF Function | All of the outputs on Basic I/O Units can be turned OFF when an error occurs in RUN or MONITOR mode. |
| | | Basic I/O Unit Status Monitoring | Alarm information can be read from Basic I/O Units and the number of Units recognized can be read. |
| | | Reading/writing data using instructions for specific Units *1 | Special instructions can be used to read/write required data for specific Units at high speed. |
| | Special I/O Units and CPU Bus Units | Unit Restart Bits to Restart Units | A Special I/O Unit or CPU Bus Unit can be restarted. |
| | | Synchronous Unit Operation *2 | The start of processing for all the specified Units can be synchronized at a fixed interval. Maximum number of Units: 10 Units (Only Units that support Synchronous Operation Mode can be used.) Synchronous operation cycle: 0.5 to 10 ms (default: 2 ms) Maximum number of words for synchronous data refreshing: 96 words (total of all Units) |
| | Configuration Management | Automatic I/O Allocation at Startup | I/O words can be automatically allocated to the Basic I/O Units that are connected in the PLC to start operation automatically without registering Units into I/O tables. |
| | | I/O Table Creation | The current unit configuration can be registered in I/O tables to prevent it from being changed, to reserve words, and to set words. |
| | | Rack/Slot First Word Settings | The first words allocated to a Units on the Racks can be set. |
| Memory Management | Holding I/O Memory when Changing Operating Modes | The status of I/O memory can be held when the operating mode is changed or power is turned ON. The forced-set/reset status can be held when the operating mode is changed or power is turned ON. | |
| | File Memory | Files (such as program files, data files, and symbol table files) can be stored in Memory Card, EM File Memory, or Comment Memory. | |
| | Built-in Flash Memory | The user program and Parameter Area can be backed up to an internal flash memory when they are transferred to the CPU Unit. | |
| | EM File Function | Parts of the EM Area can be treated as file memory. | |
| | Storing Comments | I/O comments can be stored as symbol table files in a Memory Card, EM file memory, or comment memory. | |
| | EM Configuration | EM Area can be set as trace memory or EM file memory. | |
| Memory Cards | Automatic File Transfer at Startup | A program file and parameter files can be read from a Memory Card when the power is turned ON. | |
| | Program Replacement during PLC Operation | User programs can be transferred from a Memory Card to CPU Unit during operation. | |
| | Function for Reading and Writing Data from a Memory Card | Data in I/O memory in the CPU Unit can be written to a Memory Card in CSV/TXT format. Data in CSV/TXT format in the Memory Card can be read to I/O memory in the CPU Unit. | |

*1. Supported only by the CJ2H CPU Units with unit version 1.1 or later and CJ2M CPU Units.

*2. Position Control Units (High-speed type) CJ1W-NC□□4 supported by the CJ2H CPU Units with unit version 1.1 or later.
Position Control Units with EtherCAT interface CJ1W-NC□82 are supported by the CJ2H CPU Units with unit version 1.4 or later.

■ Allocating Functions to I/O signals

Pulse I/O Module 0 (on the right)

| Terminal symbol | | IN 00 | IN 01 | IN 02 | IN 03 | IN 04 | IN 05 | IN 06 | IN 07 | IN 08 | IN 09 | OUT 00 | OUT 01 | OUT 02 | OUT 03 | OUT 04 | OUT 05 | |
|-----------------|---|---|---------------------------------------|---|--|--|----------------|---|---|---|---|-----------------|------------------------|------------------------|----------------------------|---|---|--------------|
| Address | | 2960 | | | | | | | | | | | 2961 | | | | | |
| Bit | | 0 | 1 | 2 | 3 | 4 | 5 | 6 | 7 | 8 | 9 | 0 | 1 | 2 | 3 | 4 | 5 | |
| Inputs | Normal inputs | Normal input 0 | Normal input 1 | Normal input 2 | Normal input 3 | Normal input 4 | Normal input 5 | Normal input 6 | Normal input 7 | Normal input 8 | Normal input 9 | --- | --- | --- | --- | --- | --- | |
| | Interrupt inputs (Direct Mode/Counter Mode) | Interrupt input 0 | Interrupt input 1 | Interrupt input 2 | Interrupt input 3 | --- | --- | --- | --- | --- | --- | --- | --- | --- | --- | --- | --- | |
| | Quick response inputs | Quick response input 0 | Quick response input 1 | Quick response input 2 | Quick response input 3 | --- | --- | --- | --- | --- | --- | --- | --- | --- | --- | --- | --- | |
| | High-speed counters | --- | --- | High-speed counter 1 (phase-Z/reset) | High-speed counter 0 (phase-Z/reset) | --- | --- | High-speed counter 1 (phase-A, increment, or count input) | High-speed counter 1 (phase-B, decrement, or direction input) | High-speed counter 0 (phase-A, increment, or count input) | High-speed counter 0 (phase-B, decrement, or direction input) | --- | --- | --- | --- | --- | --- | |
| Out-puts | Normal outputs | --- | --- | --- | --- | --- | --- | --- | --- | --- | --- | Normal output 0 | Normal output 1 | Normal output 2 | Normal output 3 | Normal output 4 | Normal output 5 | |
| | Pulse out-puts | CW/CCW outputs | --- | --- | --- | --- | --- | --- | --- | --- | --- | --- | Pulse output 0 (CW) | Pulse output 0 (CCW) | Pulse output 1 (CW) | Pulse output 1 (CCW) | --- | --- |
| | | Pulse + direction outputs | --- | --- | --- | --- | --- | --- | --- | --- | --- | --- | Pulse output 0 (pulse) | Pulse output 1 (pulse) | Pulse output 0 (direction) | Pulse output 1 (direction) | --- | --- |
| | | Variable duty ratio outputs | --- | --- | --- | --- | --- | --- | --- | --- | --- | --- | --- | --- | --- | --- | PWM output 0 | PWM output 1 |
| Origin search | Origin search 0 (Origin Input Signal) | Origin search 0 (Origin Proximity Input Signal) | Origin search 1 (Origin Input Signal) | Origin search 1 (Origin Proximity Input Signal) | Origin search 0 (Positioning Completed Signal) | Origin search 1 (Positioning Completed Signal) | --- | --- | --- | --- | --- | --- | --- | --- | --- | Pulse output 0 error counter reset output (operation modes 1 and 2) | Pulse output 1 error counter reset output (operation modes 1 and 2) | |

Pulse I/O Module 1 (on the left)

| Terminal symbol | | IN 10 | IN 11 | IN 12 | IN 13 | IN 14 | IN 15 | IN 16 | IN 17 | IN 18 | IN 19 | OUT 10 | OUT 11 | OUT 12 | OUT 13 | OUT 14 | OUT 15 | |
|-----------------|---|---|---------------------------------------|---|--|--|-----------------|---|---|---|---|-----------------|------------------------|------------------------|----------------------------|---|---|--------------|
| Address | | 2962 | | | | | | | | | | | 2963 | | | | | |
| Bit | | 0 | 1 | 2 | 3 | 4 | 5 | 6 | 7 | 8 | 9 | 0 | 1 | 2 | 3 | 4 | 5 | |
| Inputs | Normal inputs | Normal input 10 | Normal input 11 | Normal input 12 | Normal input 13 | Normal input 14 | Normal input 15 | Normal input 16 | Normal input 17 | Normal input 18 | Normal input 19 | --- | --- | --- | --- | --- | --- | |
| | Interrupt inputs (Direct Mode/Counter Mode) | Interrupt input 4 | Interrupt input 5 | Interrupt input 6 | Interrupt input 7 | --- | --- | --- | --- | --- | --- | --- | --- | --- | --- | --- | --- | |
| | Quick response inputs | Quick response input 4 | Quick response input 5 | Quick response input 6 | Quick response input 7 | --- | --- | --- | --- | --- | --- | --- | --- | --- | --- | --- | --- | |
| | High-speed counters | --- | --- | High-speed counter 3 (phase-Z/reset) | High-speed counter 2 (phase-Z/reset) | --- | --- | High-speed counter 3 (phase-A, increment, or count input) | High-speed counter 3 (phase-B, decrement, or direction input) | High-speed counter 2 (phase-A, increment, or count input) | High-speed counter 2 (phase-B, decrement, or direction input) | --- | --- | --- | --- | --- | --- | |
| Out-puts | Normal outputs | --- | --- | --- | --- | --- | --- | --- | --- | --- | --- | Normal output 6 | Normal output 7 | Normal output 8 | Normal output 9 | Normal output 10 | Normal output 11 | |
| | Pulse out-puts | CW/CCW outputs | --- | --- | --- | --- | --- | --- | --- | --- | --- | --- | Pulse output 2 (CW) | Pulse output 2 (CCW) | Pulse output 3 (CW) | Pulse output 3 (CCW) | --- | --- |
| | | Pulse + direction outputs | --- | --- | --- | --- | --- | --- | --- | --- | --- | --- | Pulse output 2 (pulse) | Pulse output 3 (pulse) | Pulse output 2 (direction) | Pulse output 3 (direction) | --- | --- |
| | | Variable duty ratio outputs | --- | --- | --- | --- | --- | --- | --- | --- | --- | --- | --- | --- | --- | --- | PWM output 2 | PWM output 3 |
| Origin search | Origin search 2 (Origin Input Signal) | Origin search 2 (Origin Proximity Input Signal) | Origin search 3 (Origin Input Signal) | Origin search 3 (Origin Proximity Input Signal) | Origin search 2 (Positioning Completed Signal) | Origin search 3 (Positioning Completed Signal) | --- | --- | --- | --- | --- | --- | --- | --- | --- | Pulse output 2 error counter reset output (operation modes 1 and 2) | Pulse output 3 error counter reset output (operation modes 1 and 2) | |

■ Specifications of Pulse Input Functions

● Interrupt Inputs

| Item | Direct Mode | Counter Mode |
|--|--------------------------------------|---|
| Number of interrupt inputs | Max. 8 inputs | |
| Allocated bit | CIO 2960 and CIO 2962, bits 00 to 03 | |
| Interrupt detection method | ON-to-OFF or OFF-to-ON transitions | |
| Interrupt task numbers | 140 to 147 (fixed) | |
| Counting method | --- | Incrementing or decrementing (Set with the MSKS(690) instruction.) |
| Counting range | --- | 0001 to FFFF hex (16 bits) (Set in A532 to A535 and A544 to A547.) |
| Response frequency | --- | Single-phase: 3 kHz x 8 inputs |
| Storage locations for PVs for interrupt inputs in Counter Mode | --- | A536 to A539 and A548 to A551 |

● Quick-response inputs

| Item | Specifications |
|---------------------------------|--|
| Number of Quick-response inputs | Max. 8 inputs |
| Quick-response inputs | Signals that are shorter than the cycle time are latched for one PLC cycle, so they can be detected in the PLC program. Minimum detectable pulse width is 30 μs. |

● High-speed Counter Inputs

| Item | Description | | | |
|---|---|---|-----------------------------------|-----------------------------------|
| Number of High-speed Counter Inputs | Max. 4 inputs | | | |
| Pulse input method (counting mode) | Incremental pulse inputs | Differential phase input (4×) | Up/down inputs | Pulse + direction inputs |
| Input signals | Increment pulse | Phase A | Up pulse | Pulse |
| | --- | Phase B | Down pulse | Direction |
| | --- | Phase Z | Reset | Reset |
| Frequency and number of high-speed counters | 100 kHz, 2 inputs × 2 I/O Modules | 50 kHz, 2 inputs × 2 I/O Modules | 100 kHz, 2 inputs × 2 I/O Modules | 100 kHz, 2 inputs × 2 I/O Modules |
| Counting mode | Linear mode or ring mode | | | |
| Count value | Linear mode: 8000 0000 to 7FFF FFFF hex 0000 0000 to FFFF FFFF hex (for increment pulse) Ring mode: 0000 0000 to Max. ring value | | | |
| High-speed counter PV storage locations | High-speed counter 0: A271 (upper 4 digits) and A270 (lower 4 digits) High-speed counter 1: A273 (upper 4 digits) and A272 (lower 4 digits) High-speed counter 2: A317 (upper 4 digits) and A316 (lower 4 digits) High-speed counter 3: A319 (upper 4 digits) and A318 (lower 4 digits) Refreshed during overseeing processing. Use PRV(881) to read the most recent PVs. | | | |
| | Data format: 8 digit hexadecimal • Linear mode: 8000 0000 to 7FFF FFFF hex 0000 0000 to FFFF FFFF hex (for increment pulse) • Ring mode: 0000 0000 to Max. ring value | | | |
| Control method | Target value comparison | Up to 48 target values and corresponding interrupt task numbers can be registered. | | |
| | Range Comparison | Up to 8 or up to 32 ranges can be registered, with a separate upper limit, lower limit, and interrupt task number for each range. | | |
| Counter reset method | <ul style="list-style-type: none"> Phase-Z + Software reset The counter is reset when the phase-Z input goes ON while the Reset Bit (A531.00 to A531.03) is ON. Software reset The counter is reset when the Reset Bit (A531.00 to A531.03) is turned ON. Operation can be set to stop or continue the comparison operation when the high-speed counter is reset. | | | |

■ Specifications of Pulse Output Functions

● Position Control and Speed Control

| Item | Specifications |
|--|---|
| Number of Pulse Outputs | Max. 4 outputs (Pulse Output 00 to 03) |
| Output mode | Continuous mode (for speed control) or independent mode (for position control) |
| Positioning (independent mode) instructions | PULS (886) and SPED (885), PULS (886) and ACC (888), or PULS2 (887) instruction |
| Speed control (continuous mode) instructions | SPED(885) and ACC (888) instructions |
| Origin (origin search and origin return) instructions | ORG (889) instruction |
| Interrupt feeding instruction | IFEED (892) instruction |
| Output frequency | 1 pps to 100 kpps (1 pps units), two pulse outputs × 2 Pulse I/O Modules |
| Frequency acceleration and deceleration rates | Set in increments of 1 pps for acceleration/deceleration rates from 1 to 65,535 pps (every 4 ms). The acceleration and deceleration rates can be set independently only with the PLS2 (887) instruction. |
| Changing SVs during instruction execution | The target frequency, acceleration/deceleration rate, and target position can be changed. |
| Pulse output method | CW/CCW or pulse + direction |
| Number of output pulses | Relative coordinates: 0000 0000 to 7FFF FFFF hex (Accelerating or decelerating in either direction: 2,147,483,647) Absolute coordinates: 8000 0000 to 7FFF FFFF hex (-2,147,483,648 to 2,147,483,647) |
| Relative/absolute coordinate specifications for pulse output PVs | Absolute coordinates are specified automatically when the origin location has been defined by changing the pulse output PV with the INI (880) instruction or performing an origin search with the ORG(889) instruction. Relative coordinates must be used when the origin is undefined. |
| Relative pulse/absolute pulse specifications | The pulse type can be specified with an operand in the PULS (886) or PLS2 (887) instruction. Absolute pulses can be used when absolute coordinates are specified for the pulse output PV, i.e. the origin location has been defined. Absolute pulse cannot be used when relative coordinates are specified, i.e., when the origin location is undefined. An instruction error will occur. |
| Pulse output PV's storage location | The following Auxiliary Area words contain the pulse output PVs Pulse output 0: A277 (leftmost 4 digits) and A276 (rightmost 4 digits) Pulse output 1: A279 (leftmost 4 digits) and A278 (rightmost 4 digits) Pulse output 2: A323 (leftmost 4 digits) and A322 (rightmost 4 digits) Pulse output 3: A325 (leftmost 4 digits) and A324 (rightmost 4 digits) The PVs are refreshed during regular I/O refreshing. |

● Variable-duty Pulse Outputs (PWM)

| Item | Specifications |
|-----------------------|---|
| Number of PWM Outputs | Max. 4 outputs (PWM Output 00 to 03) |
| Duty ratio | 0.0% to 100.0% in 0.1% increments |
| Frequency | 0.1 Hz to 6,553.5 Hz (Set in 0.1-Hz increments.) 1 Hz to 32,800 Hz (Set in 1-Hz increments.) |
| Output mode | Continuous Mode |
| Instruction | PWM (891) instruction |

■ Specifications of Pulse I/O Modules

● Input Specifications (IN00 to IN09/IN10 to IN19)

Normal Inputs

| Inputs | IN00 to IN05 and IN10 to IN15 | IN06 to IN09 and IN16 to IN19 | IN00 to IN05 and IN10 to IN15 | IN06 to IN09 and IN16 to IN19 |
|---------------------|--|-------------------------------|--|-------------------------------|
| Input form | 24-VDC inputs | | Line driver inputs | |
| Input current | 6.0 mA typical | 5.5 mA typical | 13 mA typical | 10 mA typical |
| Input voltage range | 24 VDC +10%/–15% | | RS-422A or RS-422 line driver (conforming to AM26LS31), Power supply voltage of 5 V ± 5% | |
| Input impedance | 3.6 kΩ | 4.0 kΩ | --- | |
| Number of circuits | 1 common, 1 circuit | | | |
| ON voltage/current | 17.4 VDC min., 3 mA min. | | --- | |
| OFF voltage/current | 1 mA max. at 5 VDC max. | | --- | |
| ON response time | 8 ms max. (The input time constant can be set to 0, 0.5, 1, 2, 4, 8, 16, or 32 ms in the PLC Setup.) | | | |
| OFF response time | 8 ms max. (The input time constant can be set to 0, 0.5, 1, 2, 4, 8, 16, or 32 ms in the PLC Setup.) | | | |

Input Circuit Configuration

| Item | Specifications | |
|-----------------------|---------------------------|---------------------------|
| Input | IN00 to IN05/IN10 to IN15 | IN06 to IN09/IN16 to IN19 |
| Circuit configuration | | |

Interrupt Input and Quick-response Input Specifications (IN00 to IN03 and IN10 to IN13)

| Item | Specifications |
|-------------------|----------------|
| ON response time | 30 μs max. |
| OFF response time | 150 μs max. |
| Response pulse | |

Output Specifications (OUT00 to OUT05 and OUT10 to OUT15)

| Item | Specifications | |
|--|------------------------------|----------------------------|
| Output Specifications | Sinking-type (CJ2M-MD211) | Sourcing-type (CJ2M-MD212) |
| Rated voltage | 5 to 24 VDC | |
| Allowable voltage range | 4.75 to 26.4 VDC | |
| Maximum switching current | 0.3 A/output, 1.8 A/Unit | |
| Number of circuits | 6 outputs (6 outputs/common) | |
| Maximum inrush current | 3.0 A/output, 10 ms max. | 2.0 A/output, 10 ms max. |
| Leakage current | 0.1 mA max. | |
| Residual voltage | 0.6 V max. | |
| ON response time | 0.1 ms max. | |
| OFF response time | 0.1 ms max. | |
| Fuse | None | |
| External supply power (power supply input for outputs) | 10.2 to 26.4 VDC, 20 mA min. | |
| Circuit configuration | | |

Pulse Outputs (OUT00 to OUT03 and OUT10 to OUT13)

| Item | Specifications | |
|----------------------------|---------------------------|----------------------------|
| Output Specifications | Sinking-type (CJ2M-MD211) | Sourcing-type (CJ2M-MD212) |
| Rated voltage | 5 to 24 VDC | |
| Allowable voltage range | 4.75 to 26.4 VDC | |
| Maximum switching capacity | 30 mA | |
| Minimum switching capacity | 7 mA | |
| Maximum output frequency | 100 kHz | |
| Output waveform | | |

PWM Outputs (OUT04, OUT05, OUT14, and OUT15)

| Item | Specifications | |
|--|--|--|
| Output Specifications | Sinking-type (CJ2M-MD211) | Sourcing-type (CJ2M-MD212) |
| Rated voltage | 5 to 24 VDC | |
| Allowable voltage range | 4.75 to 26.4 VDC | |
| Maximum switching capacity | 6.5535 kHz or less: 300 mA, 6.5535 to 32.8 kHz: 100 mA | |
| Maximum output frequency | 32,800 Hz | |
| PWM output accuracy (for ON pulse width of 2 μs or longer) | ON duty at 6.5535 kHz or less: -0.2% to +1%, ON duty at 32.8 kHz: -1% to +5% (at switching current of 30 mA) | ON duty at 6.5535 kHz or less: ±0.5%, ON duty at 32.8 kHz: ±2.5% (at switching current of 30 mA) |
| Output waveform | | |

Ordering Information

| | |
|--|----|
| Basic Configuration Units | 32 |
| Programming Devices | 37 |
| Programming Device Connecting Cable..... | 38 |
| FA Communications Software | 39 |
| Optional Products and Maintenance Products | 40 |
| DIN Track Accessories | 40 |
| Basic I/O Units | 41 |
| Special I/O Units and CPU Bus Units | 47 |

International Standards

- The standards are abbreviated as follows: U: UL, U1: UL (Class I Division 2 Products for Hazardous Locations), C: CSA, UC: cULus, UC1: cULus (Class I Division 2 Products for Hazardous Locations), CU: cUL, N: NK, L: Lloyd, CE: EC Directives, and KC: KC Registration.
- Contact your OMRON representative for further details and applicable conditions for these standards.
- Refer to the OMRON website (www.ia.omron.com) or ask your OMRON representative for the most recent applicable standards for each model.

● EC Directives

The EC Directives applicable to PLCs include the EMC Directives and the Low Voltage Directive. OMRON complies with these directives as described below.

- EMC Directives
Applicable Standards
EMI: EN61000-6-4, EN61131-2
EMS: EN61000-6-2, EN61131-2

PLCs are electrical devices that are incorporated in machines and manufacturing installations. OMRON PLCs conform to the related EMC standards so that the devices and machines into which they are built can more easily conform to EMC standards. The actual PLCs have been checked for conformity to EMC standards. Whether these

standards are satisfied for the actual system, however, must be checked by the customer.

EMC-related performance will vary depending on the configuration, wiring, and other conditions of the equipment or control panel in which the PLC is installed. The customer must, therefore, perform final checks to confirm that the overall machine or device conforms to EMC standards.

● Low Voltage Directive

Applicable Standard:EN61131-2

VDC must satisfy the appropriate safety requirements. With PLCs, this applies to Power Supply Units and I/O Units that operate in these voltage ranges.

These Units have been designed to conform to EN61131-2, which is the applicable standard for PLCs.

Ordering Information

Basic Configuration Units

CPU Units

■ CJ2H (Built-in EtherNet/IP) CPU Units

| Product name | Specifications | | | | Current consumption (A) | | Model | Standards |
|---|---|------------------|--|-------------------------------|-------------------------|------|----------------|------------------|
| | I/O capacity/ Mountable Units (Expansion Racks) | Program capacity | Data memory capacity | LD instruction execution time | 5 V | 24 V | | |
| CJ2H (Built-in EtherNet/IP) CPU Units  | 2,560 points/ 40 Units (3 Expansion Racks max.) | 400K steps | 832K words (DM: 32K words, EM: 32K words × 25 banks) | 0.016 μs | 0.82 (See note.) | --- | CJ2H-CPU68-EIP | UC1, N, L, CE |
| | | 250K steps | 512K words (DM: 32K words, EM: 32K words × 15 banks) | | | | CJ2H-CPU67-EIP | |
| | | 150K steps | 352K words (DM: 32K words, EM: 32K words × 10 banks) | | | | CJ2H-CPU66-EIP | |
| | | 100K steps | 160K words (DM: 32K words, EM: 32K words × 4 bank) | | | | CJ2H-CPU65-EIP | |
| | | 50K steps | 160K words (DM: 32K words, EM: 32K words × 4 bank) | | | | CJ2H-CPU64-EIP | |

Note: Add 0.15 A per Adapter when using NT-AL001 RS-232C/RS-222A Adapters.
 Add 0.04 A per Adapter when using CJ1W-CIF11 RS-422A Adapters.
 Add 0.20A/Unit when using NV3W-M□20L(-V1) Programmable Terminals.

■ CJ2H CPU Units

| Product name | Specifications | | | | Current consumption (A) | | Model | Standards |
|--|---|------------------|--|-------------------------------|-------------------------|------|------------|------------------|
| | I/O capacity/ Mountable Units (Expansion Racks) | Program capacity | Data memory capacity | LD instruction execution time | 5 V | 24 V | | |
| CJ2H CPU Units  | 2,560 points/ 40 Units (3 Expansion Racks max.) | 400K steps | 832K words (DM: 32K words, EM: 32K words × 25 banks) | 0.016 μs | 0.42 (See note.) | --- | CJ2H-CPU68 | UC1, N, L, CE |
| | | 250K steps | 512K words (DM: 32K words, EM: 32K words × 15 banks) | | | | CJ2H-CPU67 | |
| | | 150K steps | 352K words (DM: 32K words, EM: 32K words × 10 banks) | | | | CJ2H-CPU66 | |
| | | 100K steps | 160K words (DM: 32K words, EM: 32K words × 4 bank) | | | | CJ2H-CPU65 | |
| | | 50K steps | 160K words (DM: 32K words, EM: 32K words × 4 bank) | | | | CJ2H-CPU64 | |

Note: Add 0.15 A per Adapter when using NT-AL001 RS-232C/RS-222A Adapters.
 Add 0.04 A per Adapter when using CJ1W-CIF11 RS-422A Adapters.
 Add 0.20A/Unit when using NV3W-M□20L(-V1) Programmable Terminals.

■ CJ2M CPU Units (Built-in EtherNet/IP)

| Product name | Specifications | | | | | | Current consumption (A) | | Model | Standards |
|---|---|------------------|--|-------------------------------|----------------------|-------------------|-------------------------|------|------------|---------------|
| | I/O capacity/ Mountable Units (Expansion Racks) | Program capacity | Data memory capacity | LD instruction execution time | EtherNet/IP function | Option board slot | 5 V | 24 V | | |
| CJ2M (Built-in EtherNet/IP) CPU Units  | 2,560 points/ 40 Units (3 Expansion Racks max.) | 60K steps | 160K words (DM: 32K words, EM: 32K words × 4 banks) | 0.04 μs | YES | YES | 0.7 (See note.) | --- | CJ2M-CPU35 | UC1, N, L, CE |
| | | 30K steps | | | | | | | CJ2M-CPU34 | |
| | | 20K steps | 64K words (DM: 32K words, EM: 32K words × 1 bank) | | | | | | CJ2M-CPU33 | |
| | | 10K steps | | | | | | | CJ2M-CPU32 | |
| | | 5K steps | | | | | | | CJ2M-CPU31 | |

Note: Add 0.005A, 0.030A, and 0.075A when using Serial Communications Option Boards (CP1W-CIF01/CIF11/CIF12-V1), respectively.
 Add 0.15A/Unit when using NT-AL001 RS-232C/RS-422A Adapters.
 Add 0.04A/Unit when using CJ1W-CIF11 RS-422A Adapters.
 Add 0.20A/Unit when using NV3W-M□20L(-V1) Programmable Terminals.

■ CJ2M CPU Units

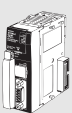
| Product name | Specifications | | | | | | Current consumption (A) | | Model | Standards |
|---|---|------------------|--|-------------------------------|----------------------|-------------------|-------------------------|------|------------|---------------|
| | I/O capacity/ Mountable Units (Expansion Racks) | Program capacity | Data memory capacity | LD instruction execution time | EtherNet/IP function | Option board slot | 5 V | 24 V | | |
| CJ2M CPU Units  | 2,560 points/ 40 Units (3 Expansion Racks max.) | 60K steps | 160K words (DM: 32K words, EM: 32K words × 4 banks) | 0.04 μs | --- | --- | 0.5 (See note.) | --- | CJ2M-CPU15 | UC1, N, L, CE |
| | | 30K steps | | | | | | | CJ2M-CPU14 | |
| | | 20K steps | 64K words (DM: 32K words, EM: 32K words × 1 bank) | | | | | | CJ2M-CPU13 | |
| | | 10K steps | | | | | | | CJ2M-CPU12 | |
| | | 5K steps | | | | | | | CJ2M-CPU11 | |

Note: Add 0.15A/Unit when using NT-AL001 RS-232C/RS-422A Adapters.
 Add 0.04A/Unit when using CJ1W-CIF11 RS-422A Adapters.
 Add 0.20A/Unit when using NV3W-M□20L(-V1) Programmable Terminals.



The following accessories are included with the CPU Unit.

| Item | Specifications |
|------------------|--|
| Battery | CJ1W-BAT01 |
| End Cover | CJ1W-TER01 (The End Cover must be connected to the right end of the CPU Rack.) |
| End Plate | PFP-M (2 stoppers) |

Note: A serial port (RS-232C) connector is not provided. Purchase a connector separately for serial port connection.
 Plug : XM3A-0921 (manufactured by OMRON) or equivalent
 Hood : XM2S-0911-E (manufactured by OMRON) or equivalent

■ Serial Communications Option Boards (Only CJ2M-CPU3□)

The serial communications port can be equipped by installing the serial communications option board to the option board slot in front of CPU unit.

| Product name | Specifications | Serial communications mode | Current consumption (A) | | Model | Standards |
|--|--|---|-------------------------|------|---------------|---------------|
| | | | 5 V | 24 V | | |
| RS-232C Option Board  | One RS-232C port Connector: D-Sub, 9 pin, female Maximum transmission distance: 15m | Host Link, 1:N NT Link, Noprotocol, Serial PLC Link Slave, Serial PLC Link Master, Serial Gateway converted to CompoWay/F, and Tool Bus * | 0.005 | --- | CP1W-CIF01 | UC1, N, L, CE |
| RS-422A/485 Option Board  | One RS-422A/485 port Terminal block: using ferrules Maximum transmission distance: 50m | | 0.030 | --- | CP1W-CIF11 | |
| RS-422A/485 Isolated-type Option Board  | One RS-422A/485 port (Isolated) Terminal block: using ferrules Maximum transmission distance: 500m | | 0.075 | --- | CP1W-CIF12-V1 | |

Note: It is not possible to use a CP-series Ethernet Option Board (CP1W-CIF41), LCD Option Board (CP1W-DAM01) with a CJ2M CPU Unit.
 * The following modes cannot be used: 1:1 NT Link, Serial Gateway converted to Host Link FINS, 1:1 Link Master, and 1:1 Link Slave.

■Pulse I/O Modules (Only CJ2M CPU Unit with Unit Version 2.0 or Later)



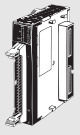





Optional Pulse I/O Modules can be mounted to enable pulse I/O. Up to two Pulse I/O Modules can be mounted to the left side of a CJ2M CPU Unit.

| Product name | Specifications | Current consumption (A) | | Model | Standards |
|---|---|-------------------------|------|------------|---------------|
| | | 5 V | 24 V | | |
|  Pulse I/O Module | Sinking outputs, MIL connector 10 inputs (including four interrupt/quickresponse inputs and two high-speed counter inputs) 6 outputs (including two pulse outputs and two PWM outputs) | 0.08 | --- | CJ2M-MD211 | UC1, N, L, CE |
| | Sourcing outputs, MIL connector 10 inputs (including four interrupt/quickresponse inputs and two high-speed counter inputs) 6 outputs (including two pulse outputs and two PWM outputs) | 0.08 | --- | CJ2M-MD212 | |

Note: Connectors are not provided with Pulse I/O Modules. Purchase the following Connector, an OMRON Cable with Connectors for Connector Terminal Block Conversion Units, or an OMRON Cable with Connectors for Servo Relay Units.

■Connecting to Pulse I/O Modules

On wiring, refer to Pulse I/O Modules Connector Wiring Methods.

| Product name | Specifications | Model | Standards |
|--|--|-----------------------------------|--------------|
| Applicable Connector | MIL Flat Cable Connectors *1  | 40-pin Pressure-welded Connectors | XG4M-4030-T |
| | MIL Loose Wire Connectors *2  | 40-pin Crimped Connectors | XG5N-401 *4 |
| | Crimp Contacts for XG5N *3  | Loose contacts | XG5W-0232 |
| | | Reel contacts | XG5W-0232-R |
| Manual Crimping Tool for XG5N  | | XY2B-7007 | |
| Connector-Terminal Block Conversion Units | Push-In Plus (Clamp 40-terminals)  | | XW2K-40G-T |
| | Phillips screw (M3 screw terminals, 40-terminals)  | | XW2D-40G6 |
| | Slotted screw (M3 European type, 40-terminals)  | | XW2R-E40GD-T |
| Cable for Connector-Terminal Block Conversion Unit |  | Cable length: 0.25 m | XW2Z-C25K |
| | | Cable length: 0.5 m | XW2Z-C50K |
| | | Cable length: 1 m | XW2Z-100K |
| | | Cable length: 1.5 m | XW2Z-150K |
| | | Cable length: 2 m | XW2Z-200K |
| | | Cable length: 3 m | XW2Z-300K |
| | | Cable length: 5 m | XW2Z-500K |

Note: Minimum ordering quantity for loose contacts is 100 pieces and for reel contacts is 1 reel (10,000 pieces).





*1. Socket and Strain Relief set

*2. Crimp Contacts (XG5W-0232) are sold separately.

*3. Applicable wire size is 28 to 24 AWG.

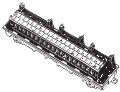
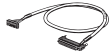
For applicable conductor construction and more information, visit the OMRON website at www.ia.omron.com.

*4. Crimp Contacts are also required.

| Product name | Specifications | | | Model | Standards |
|------------------------------|--|---|---------------------|---------------|-----------|
| Servo Relay Units | Servo Relay Unit for 1 axis  | | | XW2B-20J6-8A | |
| | Servo Relay Unit for 2 axes  | | | XW2B-40J6-9A | --- |
| Cables for Servo Relay Units | G5/G Series | Cable for Pulse I/O Modules  | Cable length: 0.5 m | XW2Z-050J-A33 | --- |
| | | Cable length: 1 m | XW2Z-100J-A33 | | |
| | | Servo Driver Connecting Cables  | Cable length: 1 m | XW2Z-100J-B31 | |
| | | Cable length: 2 m | XW2Z-200J-B31 | | |
| | SMARTSTEP2 | Cable for Pulse I/O Modules  | Cable length: 0.5 m | XW2Z-050J-A33 | |
| | | Cable length: 1 m | XW2Z-100J-A33 | | |
| | | Servo Driver Connecting Cables  | Cable length: 1 m | XW2Z-100J-B32 | |
| | | Cable length: 2 m | XW2Z-200J-B32 | | |

■ Power Supply Units

One Power Supply Unit is required for each Rack.

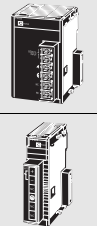
| Product name | Power supply voltage | Output capacity | | | Options | | | Model | Standards |
|---|----------------------|-----------------------|------------------------|-------------------------|-----------------------------|------------|------------------------------|-------------|---------------|
| | | 5-VDC output capacity | 24-VDC output capacity | Total power consumption | 24-VDC service power supply | RUN output | Maintenance forecast monitor | | |
|  AC Power Supply Unit | 100 to 240 VAC | 5 A | 0.8 A | 25 W | No | No | Yes | CJ1W-PA205C | UC1, N, L, CE |
| | | | | | | Yes | No | CJ1W-PA205R | |
| | | 2.8 A | 0.4 A | 14 W | | No | No | No | |
|  DC Power Supply Unit | 24 VDC | 5A | 0.8 A | 25 W | No | No | CJ1W-PD025 | | |
| | | 2 A | 0.4 A | 19.6 W | No | No | CJ1W-PD022 | UC1, CE | |

Expansion Racks

Select the I/O Control Unit, I/O Interface Unit, Expansion Connecting Cable, and Power Supply Unit.

■ CJ-series I/O Control Unit (Mounted on CPU Rack when Connecting Expansion Racks)

| Product name | Specifications | Current consumption (A) | | Model | Standards |
|---|--|-------------------------|------|------------|---------------|
| | | 5 V | 24 V | | |
|  CJ-series I/O Control Unit | Mount one I/O Control Unit on the CJ-series CPU Rack when connecting one or more CJ-series Expansion Racks. Connecting Cable: CS1W-CN□□3 Expansion Connecting Cable Connected Unit: CJ1W-II101 I/O Interface Unit Mount to the right of the CPU Unit. | 0.02 | --- | CJ1W-IC101 | UC1, N, L, CE |

Note: Mounting the I/O Control Unit in any other location may cause faulty operation.

■ CJ-series I/O Interface Unit (Mounted on Expansion Rack)

| Product Name | Specifications | Current consumption (A) | | Model | Standards |
|---|---|-------------------------|------|------------|---------------|
| | | 5 V | 24 V | | |
|  CJ-series I/O Interface Unit | One I/O Interface Unit is required on each Expansion Rack. Connecting Cable: CS1W-CN□□3 Expansion Connecting Cable Mount to the right of the Power Supply Unit. | 0.13 | --- | CJ1W-II101 | UC1, N, L, CE |

Note: Mounting the I/O Interface Unit in any other location may cause faulty operation.

■ I/O Connecting Cables

| Product name | Specifications | Model | Standards |
|---|--|---------------------|---------------|
|  I/O Connecting Cable | <ul style="list-style-type: none"> Connects an I/O Control Unit on CJ-series CPU Rack to an I/O Interface Unit on a CJ-series Expansion Rack. or Connects an I/O Interface Unit on CJ-series Expansion Rack to an I/O Interface Unit on another CJ-series Expansion Rack. | Cable length: 0.3 m | CS1W-CN313 |
| | | Cable length: 0.7 m | CS1W-CN713 |
| | | Cable length: 2 m | CS1W-CN223 |
| | | Cable length: 3 m | CS1W-CN323 |
| | | Cable length: 5 m | CS1W-CN523 |
| | | Cable length: 10 m | CS1W-CN133 |
| | | Cable length: 12 m | CS1W-CN133-B2 |
| | | | N, L, CE |

Programming Devices

■ Support Software

| Product name | Specifications | Media | | Model | Standards |
|--|---|----------------------|-----|----------------|-----------|
| | | Number of licenses | | | |
| FA Integrated Tool Package CX-One Ver. 4.□ | The CX-One is a comprehensive software package that integrates Support Software for OMRON PLCs and components. CX-One Version 4.□ includes CX-Programmer and CX-Simulator. | - (Media only) *1 | DVD | CXONE-AL00D-V4 | --- |
| | | 1 license | | CXONE-AL01D-V4 | |
| | | 3 licenses | | CXONE-AL03D-V4 | |
| | | 10 licenses | | CXONE-AL10D-V4 | |
| | | 30 licenses | | CXONE-AL30D-V4 | |
| | | 50 licenses | | CXONE-AL50D-V4 | |

Note 1. For details, refer to the CX-One Catalog (Cat. No. R134), your local OMRON website.

2. Site licenses are available for users who will run CX-One on multiple computers. Ask your OMRON sales representative for details.

*1 The CXONE-AL00D-V4 contains only the DVD installation media for users who have purchased the CX-One Version 4.□ and does not include the license number. Enter the license number of the CX-One Version 4.□ when installing. (The license number of the CX-One Version 3.□ or lower cannot be used for installation.)

Support Software in CX-One Ver.4.□

The following tables lists the Support Software that can be installed from CX-One.

| Support Software in CX-One | Outline |
|-------------------------------|--|
| CX-Programmer | Application software to create and debug programs for CS/CJ/CP/NSJ-series, C-series, and CVM1/C-series CPU Units. Data can be created and monitored for high-speed-type Position Control Units and Position Control Units with EtherCAT interface. |
| CX-Integrator | Application software to build and set up FA networks, such as Controller Link, DeviceNet, CompoNet, CompoWay, and Ethernet networks. The Routing Table Component and Data Link Component can be started from here. DeviceNet Configuration functionality is also included. |
| Switch Box Utility | Utility software that helps you to debug PLCs. It helps you to monitor the I/O status and to monitor/change present values within the PLC you specify. |
| CX-Protocol | Application software to create protocols (communications sequences) between CS/CJ/CP/NSJ-series or C200HX/HG/HE Serial Communications Boards/Units and general-purpose external devices. |
| CX-Simulator | Application software to simulate CS/CJ/CP/NSJ-series CPU Unit operation on the computer to debug PLC programs without a CPU Unit. |
| CX-Position | Application software to create and monitor data for CS/CJ-series Position Control Units. (except for High-speed type) |
| CX-Motion-NCF | Application software to create and monitor data for CS/CJ-series Position Control Units with MECHATROLINK-II interface (NC□71). |
| CX-Motion-MCH | Application software to create data and monitor program and monitor data CS/CJ-series Motion Control Units with MECHATROLINK-II interface (MCH71). |
| CX-Motion | Application software to create data for CS/CJ-series, C200HX/HG/HE, and CVM1/CV-series Motion Control Units, and to create and monitor motion control programs. |
| CX-Drive | Application software to set and control data for Inverters and Servos. |
| CX-Process Tool | Application software to create and debug function block programs for CS/CJ-series Loop Controllers (Loop Control Units/Boards, Process Control CPU Units, and Loop Control CPU Units). |
| Faceplate Auto-Builder for NS | Application software that automatically outputs screen data as project files for NS-series PTs from tag information in function block programs created with the CX-Process Tool. |
| CX-Designer | Application software to create screen data for NS-series PTs. |
| NV-Designer | Application software to create screen data for NV-series small PTs. |
| CX-Configurator FDT | Application software for setting various units by installing its DTM module. |
| CX-Thermo | Application software to set and control parameters in components such as Temperature Control Units. |
| CX-FLnet | Application software for system setting and monitoring of CS/CJ-series FL-net Units |
| Network Configurator | Application software for set up and monitor tag datalink for CJ2 (Built-in EtherNet/IP) CPU Units and EtherNet/IP Units. |
| CX-Server | Middleware necessary for CX-One applications to communicate with OMRON components, such as PLCs, Display Devices, and Temperature Control Units. |
| Communications Middleware | Middleware necessary to communicate with CP1L CPU Units with built-in Ethernet port. |
| PLC Tools | A group of components used with CX-One applications, such as the CX-Programmer and CX-Integrator. Includes the following: I/O tables, PLC memory, PLC Setup, Data Tracing/Time Chart Monitoring, PLC Error Logs, File Memory, PLC clock, Routing Tables, and Data Link Tables. |

Note: If the complete CX-One package is installed, approximately 4.0 GB of Hard disk space will be required.

Programming Device Connecting Cable

■Peripheral (USB) Port

Use commercially available USB cable.

Specifications: USB 1.1 or 2.0 cable (A connector - B connector), 5.0 m max.

■EtherNet/IP Port

Support Software can also be connected via the built-in EtherNet/IP port. Use commercially available 100Base-TX twisted-pair cable with the same specifications as for an EtherNet/IP Unit.

Specifications: Twisted-pair cable with RJ45 modular connectors at both ends. Connect between EtherNet/IP Unit or built-in EtherNet/IP port and switching hub. Use STP (shielded twisted-pair) cable of category 5 or 5e.

■ Serial Port

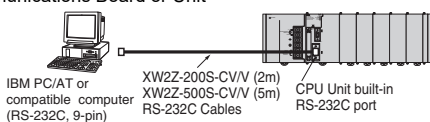
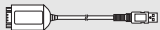
| Product Name | Specifications | | | | Model | Standards |
|--|---|---|--------------|--|--------------------------|-----------|
| | Applicable computers | Connection configuration | Cable length | Remarks | | |
| Programming Device Connecting Cables for RS-232C Port  | Connects IBM PC/AT or compatible computers, D-Sub 9-pin | IBM PC/AT or compatible computer + XW2Z-200S-CV/V or XW2Z-500S-CV/V + RS-232C port of CPU Unit or Serial Communications Board or Unit | 2 m | Used for Peripheral Bus or Host Link. Anti-static connectors | XW2Z-200S-CV | --- |
| | |  | 5 m | | XW2Z-500S-CV | |
| | | | | 2 m | Used for Host Link only. | |
| | | 5 m | | Peripheral Bus not supported. | XW2Z-500S-V | |
| USB-Serial Conversion Cable and PC driver (on a CD-ROM disk)  Complies with USB Specification 2.0 | IBM PC/AT or compatible computer (USB port) | IBM PC/AT or compatible computer + CS1W-CIF31 + XW2Z-200S-CV/500S-CV + RS-232C port of CPU Unit or Serial Communications Unit | 0.5 m | Used for Peripheral Bus or Host Link. | CS1W-CIF31 | N |
| | | IBM PC/AT or compatible computer + CS1W-CIF31 + XW2Z-200S-V/500S-V + RS-232C port of CPU Unit or Serial Communications Unit | | Connect USB Serial Conversion Cable to Serial Connecting Cable, and connect to the PLC RS-232C port. | | |

FA Communications Software

■ SYSMAC Gateway (Communications Middleware)

| Product | Specifications | Number of licenses | Media | Model |
|--------------------|---|--------------------|--------|----------------|
| | | | | |
| SYSMAC Gateway *1 | Communications middleware for personal computers running Windows. Supports CIP communications and tag data links (EtherNet/IP) in addition to FinsGateway functions. (Fins Gateway functions are included.) | 1 | CD-ROM | WS02-SGWC1 |
| | Additional licenses (This product provides only additional licenses for WS02-SGWC1. Purchase of WS02-SGWC1 is required.) | 10 | --- | WS02-SGWC1-L10 |
| SYSMAC Gateway SDK | Software development kit for creating communications programs using SYSMAC Gateway. Development languages: C, C++ | 1 *2 | CD-ROM | WS02-SGWC1S |

*1 One license is required per computer (execution environment).

*2 One license is required per computer (development environment).

SYSMAC Gateway SDK doesn't include the license of SYSMAC Gateway.

Purchase the WS02-SGWC1 separately if an execution environment is required.

■ CX-Compolet



| Product | Specifications | Number of licenses | Media | Model | |
|-------------|---|---|--------|------------|----------------|
| | | | | | |
| CX-Compolet | Software components that can make it easy to create programs for communications between a computer and controllers. | Product includes CX-Compolet and SYSMAC Gateway functions. | 1 | DVD | WS02-CPLC1 |
| | | Additional licenses (This product provides only additional licenses for WS02-CPLC1. Purchase of WS02-CPLC1 is required.) | 3 | --- | WS02-CPLC1-L3 |
| | | | 5 | --- | WS02-CPLC1-L5 |
| | | | 10 | --- | WS02-CPLC1-L10 |
| | CX-Compolet (standalone) (SYSMAC Gateway functions are not included.) | 1 | CD-ROM | WS02-CPLC2 | |

Note 1. For details, refer to the FA Communications Software Catalog (Cat. No. V302), your local OMRON website.

Note 2. One license is required per computer (execution environment).

Optional Products and Maintenance Products

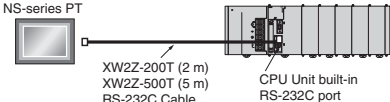

| Product name | Specifications | Model | Standards |
|--|--|-----------|-----------|
| Memory Cards  | Flash memory, 128 MB | HMC-EF183 | --- |
| | Flash memory, 256 MB | HMC-EF283 | |
| | Flash memory, 512 MB | HMC-EF583 | |
| | Memory Card Adapter (for computer PCMCIA slot) | HMC-AP001 | CE |

| Product name | Specifications | Model | Standards |
|---|---|------------|---------------|
| Battery Set  | Battery for CJ2H-CPU□□(-EIP) and CJ2M-CPU□□ CPU Unit maintenance | CJ1W-BAT01 | --- |
| | Note 1. The battery is included as a standard accessory with the CPU Unit. 2. The battery service life is 5 years at 25°C. (The service life depends on the ambient operating temperature and the power conditions.) 3. Use batteries within two years of manufacture. | | |
| | | | |
| End Cover  | Mounted to the right-hand side of CJ-series CPU Racks or Expansion Racks. | CJ1W-TER01 | UC1, N, L, CE |
| RS-422A Converter  | Converts RS-232C to RS-422A/RS-485. (Application example: With a CJ2M-CPU□ CPU Unit, the Adapter is used for Serial PLC Link at the built-in RS-232C port of the CPU Unit.) | CJ1W-CIF11 | UC1, N, L, CE |

| Product name | Specifications | | Model | Standards |
|--|---|--------------|-----------|-----------|
| | Connection configuration | Cable length | | |
| NS-series PT Connecting Cables  | Cable for connecting between an NS-series PT and the RS-232C port on the CPU Unit or Serial Communications Board  | 2 m | XW2Z-200T | --- |
| | | 5 m | XW2Z-500T | |

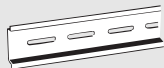

Note: NS-series PT is no longer available to order.

DIN Track Accessories

| Product name | Specifications | Model | Standards |
|---|--|-----------|-----------|
| DIN Track  | Length: 0.5 m; Height: 7.3 mm | PFP-50N | --- |
| | Length: 1 m; Height: 7.3 mm | PFP-100N | |
| | Length: 1 m; Height: 16 mm | PFP-100N2 | |
| End Plate  | There are 2 stoppers provided with CPU Units and I/O Interface Units as standard accessories to secure the Units on the DIN Track. | PFP-M | |



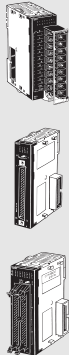

Basic I/O Units

■ Input Units

| Unit classification | Product name | Specifications | | | | | Current consumption (A) | | Model | Standards |
|---------------------------|--|-------------------------------------|--|----------------------|--------------------------|------------------------|-------------------------|------|---------------------------|---------------|
| | | I/O points | Input voltage and current | Commons | External connection | No. of words allocated | 5 V | 24 V | | |
| CJ1 Basic I/O Units | DC Input Units  | 8 inputs | 12 to 24 VDC, 10 mA | Independent contacts | Removable terminal block | 1 word | 0.08 | --- | CJ1W-ID201 | UC1, N, L, CE |
| | | 16 inputs | 24 VDC, 7 mA | 16 points, 1 common | Removable terminal block | 1 word | 0.08 | --- | CJ1W-ID211 | |
| | | 16 inputs <i>High-speed type</i> | 24 VDC, 7 mA | 16 points, 1 common | Removable terminal block | 1 word | 0.13 | --- | CJ1W-ID212 | |
| | | 32 inputs | 24 VDC, 4.1 mA | 16 points, 1 common | Fujitsu / OTAX connector | 2 words | 0.09 | --- | CJ1W-ID231 (See note.) | |
| | | 32 inputs | 24 VDC, 4.1 mA | 16 points, 1 common | MIL connector | 2 words | 0.09 | --- | CJ1W-ID232 (See note.) | |
| | | 32 inputs <i>High-speed type</i> | 24 VDC, 4.1 mA | 16 points, 1 common | MIL connector | 2 words | 0.20 | --- | CJ1W-ID233 (See note.) | |
| | | 64 inputs | 24 VDC, 4.1 mA | 16 points, 1 common | Fujitsu / OTAX connector | 4 words | 0.09 | --- | CJ1W-ID261 (See note.) | |
| | | 64 inputs | 24 VDC, 4.1 mA | 16 points, 1 common | MIL connector | 4 words | 0.09 | --- | CJ1W-ID262 (See note.) | |
| | AC Input Units  | 8 inputs | 200 to 24 VAC, 10 mA (200 V, 50 Hz) | 8 points, 1 common | Removable Terminal Block | 1 word | 0.08 | --- | CJ1W-IA201 | |
| | | 16 inputs | 100 to 120 VAC, 7 mA (100 V, 50 Hz) | 16 points, 1 common | Removable Terminal Block | 1 word | 0.09 | --- | CJ1W-IA111 | |



Note: Connectors are not provided with these connector models. Either purchase one of the following 40-pin Connectors, or use an OMRON XW2K Series Datasheet (Cat. No. G152), XW2R Series Catalog (Cat. No. G077) and XW2D Series Datasheet or a G7□ I/O Relay Terminal.

■ Output Units

| Unit classification | Product name | Specifications | | | | | No. of words allocated | Current consumption (A) | | Model | Standards |
|---------------------|---|---|--|---|----------------------|--------------------------|------------------------|-------------------------|------------|------------------------|---------------|
| | | Output type | I/O points | Maximum switching capacity | Commons | External connection | | 5 V | 24 V | | |
| CJ1 Basic I/O Units | Relay Contact Output Units  | – | 8 outputs | 250 VAC/24 VDC, 2 A | Independent contacts | Removable terminal block | 1 word | 0.09 | 0.048 max. | CJ1W-OC201 | UC1, N, L, CE |
| | | – | 16 outputs | 250 VAC/24 VDC, 2 A | 16 points, 1 common | Removable terminal block | 1 word | 0.11 | 0.096 max. | CJ1W-OC211 | |
| | Triac Output Unit  | – | 8 outputs | 250 VAC, 0.6 A | 8 points, 1 common | Removable terminal block | 1 word | 0.22 | – | CJ1W-OA201 | |
| | Transistor Output Units    | Sinking | 8 outputs | 12 to 24 VDC, 2 A | 4 points, 1 common | Removable terminal block | 1 word | 0.09 | – | CJ1W-OD201 | |
| | | Sinking | 8 outputs | 12 to 24 VDC, 0.5 A | 8 points, 1 common | Removable terminal block | 1 word | 0.10 | – | CJ1W-OD203 | |
| | | Sinking | 16 outputs | 12 to 24 VDC, 0.5 A | 16 points, 1 common | Removable terminal block | 1 word | 0.10 | – | CJ1W-OD211 | |
| | | Sinking | 16 outputs <small>High-speed type</small> | 24 VDC, 0.5 A | 16 points, 1 common | Removable terminal block | 1 word | 0.15 | – | CJ1W-OD213 | |
| | | Sinking | 32 outputs | 12 to 24 VDC, 0.5 A | 16 points, 1 common | Fujitsu / OTAX connector | 2 words | 0.14 | – | CJ1W-OD231 (See note.) | |
| | | Sinking | 32 outputs | 12 to 24 VDC, 0.5 A | 16 points, 1 common | MIL connector | 2 words | 0.14 | – | CJ1W-OD233 (See note.) | |
| | | Sinking | 32 outputs <small>High-speed type</small> | 24 VDC, 0.5 A | 16 points, 1 common | MIL connector | 2 words | 0.22 | – | CJ1W-OD234 (See note.) | |
| | | Sinking | 64 outputs | 12 to 24 VDC, 0.3 A | 16 points, 1 common | Fujitsu / OTAX connector | 4 words | 0.17 | – | CJ1W-OD261 (See note.) | |
| | | Sinking | 64 outputs | 12 to 24 VDC, 0.3 A | 16 points, 1 common | MIL connector | 4 words | 0.17 | – | CJ1W-OD263 (See note.) | |
| | | Sourcing | 8 outputs | 24 VDC, 2 A Short-circuit protection | 4 points, 1 common | Removable terminal block | 1 word | 0.11 | – | CJ1W-OD202 | |
| | | Sourcing | 8 outputs | 24 VDC, 0.5 A Short-circuit protection | 8 points, 1 common | Removable terminal block | 1 word | 0.10 | – | CJ1W-OD204 | |
| | | Sourcing | 16 outputs | 24 VDC, 0.5 A Short-circuit protection | 16 points, 1 common | Removable terminal block | 1 word | 0.10 | – | CJ1W-OD212 | |
| Sourcing | 32 outputs | 24 VDC, 0.5 A Short-circuit protection | 16 points, 1 common | MIL connector | 2 words | 0.15 | – | CJ1W-OD232 (See note.) | | | |
| Sourcing | 64 outputs | 12 to 24 VDC, 0.3 A | 16 points, 1 common | MIL connector | 4 words | 0.17 | – | CJ1W-OD262 (See note.) | | | |

Note: Connectors are not provided with these connector models. Either purchase one of the following 40-pin Connectors, or use an OMRON XW2K Series Datasheet (Cat. No. G152), XW2R Series Catalog (Cat. No. G077) and XW2D Series Datasheet or a G7□ I/O Relay Terminal.

■ I/O Units

| Unit classification | Product name | Specifications | | | | | | Current consumption (A) | | Model | Standards |
|--|--|----------------|--|------------------------------|---------------------|--------------------------|------------------------|-------------------------|--------------------------|--------------------------|------------|
| | | Output type | I/O points | Input voltage, Input current | Commons | External connection | No. of words allocated | 5 V | 24 V | | |
| | | | | Maximum switching capacity | | | | | | | |
| CJ1 Basic I/O Units | DC Input/Transistor Output Units  | Sinking | 16 inputs | 24 VDC, 7 mA | 16 points, 1 common | Fujitsu / OTAX connector | 2 words | 0.13 | --- | CJ1W-MD231 (See note 2.) | UC1, N, CE |
| | | | 16 outputs | 250 VAC/24 VDC, 0.5 A | 16 points, 1 common | | | | | | |
| | | Sinking | 16 inputs | 24 VDC, 7 mA | 16 points, 1 common | MIL connector | 2 words | 0.13 | --- | CJ1W-MD233 (See note 2.) | UC1, N, CE |
| | | | 16 outputs | 12 to 24 VDC, 0.5 A | 16 points, 1 common | | | | | | |
| | | Sinking | 32 inputs | 24 VDC, 4.1 mA | 16 points, 1 common | Fujitsu / OTAX connector | 4 words | 0.14 | --- | CJ1W-MD261 (See note 1.) | |
| | | | 32 outputs | 12 to 24 VDC, 0.3 A | 16 points, 1 common | | | | | | |
| | Sinking | 32 inputs | 24 VDC, 4.1 mA | 16 points, 1 common | MIL connector | 4 words | 0.14 | --- | CJ1W-MD263 (See note 1.) | | |
| | | 32 outputs | 12 to 24 VDC, 0.3 A | 16 points, 1 common | | | | | | | |
| | Sourcing | 16 inputs | 24 VDC, 7 mA | 16 points, 1 common | MIL connector | 2 words | 0.13 | --- | CJ1W-MD232 (See note 2.) | UC1, N, L, CE | |
| | | 16 outputs | 24 VDC, 0.5 A Short-circuit protection | 16 points, 1 common | | | | | | | |
| TTL I/O Units  | --- | 32 inputs | 5 VDC, 35 mA | 16 points, 1 common | MIL connector | 4 words | 0.19 | --- | CJ1W-MD563 (See note 1.) | UC1, N, CE | |
| | | 32 outputs | 5 VDC, 35 mA | 16 points, 1 common | | | | | | | |

Note 1. Connectors are not provided with these connector models. Either purchase one of the following 40-pin Connectors, or use an OMRON XW2K Series Datasheet (Cat. No. G152), XW2R Series Catalog (Cat. No. G077) and XW2D Series Datasheet or a G7□ I/O Relay Terminal.

Note 2. Connectors are not provided with these connector models. Either purchase one of the following 20-pin or 24-pin Connectors, or use an OMRON XW2K Series Datasheet (Cat. No. G152), XW2R Series Catalog (Cat. No. G077) and XW2D Series Datasheet or a G7□ I/O Relay Terminal.

● Applicable Connectors

Fujitsu / OTAX Connectors for 32-input, 32-output, 64-input, 64-output, 32-input/32-output, and 16-input/16-output Units

| Name | Connection | Remarks | Applicable Units | Model | Standards |
|-------------------|--|---|--|------------|-----------|
| 40-pin Connectors | Soldered | Connector Fujitsu FCN-361J040-AU Connector Cover Fujitsu FCN-360C040-J2 OTAX N360C040J2 | Fujitsu / OTAX Connectors: CJ1W-ID231 (32 inputs): 1 per Unit CJ1W-ID261 (64 inputs): 2 per Unit CJ1W-OD231 (32 outputs): 1 per Unit CJ1W-OD261 (64 outputs): 2 per Unit CJ1W-MD261 (32 inputs, 32 outputs): 2 per Unit | C500-CE404 | --- |
| | Crimped | Socket Fujitsu FCN-363J040 OTAX N363J040 | | C500-CE405 | |
| | | Contactors Fujitsu FCN-363J-AU OTAX N363JAU | | | |
| | | Connector Cover Fujitsu FCN-360C040-J2 OTAX N360C040J2 | | | |
| Pressure welded | Fujitsu FCN-367J040-AU/F | | C500-CE403 | | |
| 24-pin Connectors | Soldered | Connector Fujitsu FCN-361J024-AU Connector Cover Fujitsu FCN-360C024-J2 OTAX N360C024J2 | Fujitsu / OTAX Connectors: CJ1W-MD231 (16 inputs, 16 outputs): 2 per Unit | C500-CE241 | --- |
| | Crimped | Socket Fujitsu FCN-363J024 OTAX N363J024 | | C500-CE242 | |
| | | Contactors Fujitsu FCN-363J-AU OTAX N363JAU | | | |
| | | Connector Cover Fujitsu FCN-360C024-J2 OTAX N360C024J2 | | | |
| Pressure welded | Fujitsu FCN-367J024-AU/F OTAX N367J024AUF | | C500-CE243 | | |

MIL Connectors for 32-input, 32-output, 64-input, 64-output, 32-input/32-output, and 16-input/16-output Units

| Name | Connection | Remarks | Applicable Units | Model | Standards |
|-------------------|-----------------|----------------|---|-------------|-----------|
| 40-pin Connectors | Pressure welded | FRC5-AO40-3TOS | MIL Connectors: CJ1W-ID232/233 (32 inputs): 1 per Unit CJ1W-OD232/233/234 (32 outputs): 1 per Unit CJ1W-ID262 (64 inputs): 2 per Unit CJ1W-OD262/263 (64 outputs): 2 per Unit CJ1W-MD263/563 (32 inputs, 32 outputs): 2 per Unit | XG4M-4030-T | --- |
| 20-pin Connectors | Pressure welded | FRC5-AO20-3TOS | MIL Connectors: CJ1W-MD232/233 (16 inputs, 16 outputs): 2 per Unit | XG4M-2030-T | |

● Applicable Connector-terminal block conversion unit

Example: With OMRON Connector-terminal block conversion unit

Only main products are shown here.

More detail informations are shown in *XW2K Series Datasheet* (Cat. No. G152), *XW2R Series Catalog* (Cat. No. G077) and *XW2D Series Datasheet*

32-point Input Unit or Output Unit

CJ1W-ID231 32-point

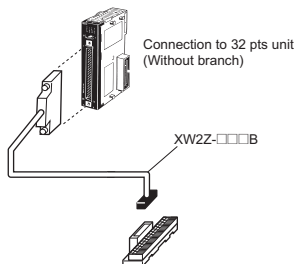

64-point Input Unit or Output Unit

CJ1W-ID261 64-point

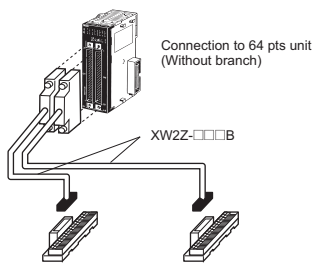

64-point Output Unit

CJ1W-MD563 IN 32 Points, OUT 32 Points

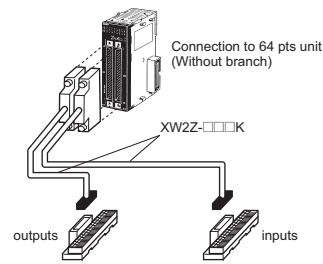

Choose the wiring method.

Choose □□ from a following combination table PLC type.

| Wiring method | Model |
|-------------------------------------|---------------|
| Models with Push-In Plus | XW2K-40G-O32□ |
| Models with Phillips screw | XW2R-J34GD-C□ |
| Models with Slotted screw (rise up) | XW2R-E34GD-C□ |

Combination table

| PLC Type (Connector-terminal block) | | PLC | | | Connecting cables |
|-------------------------------------|------|--------------|------------|----------------------|--|
| XW2K | XW2R | I/O | I/O Points | I/O unit model | |
| O32A | C1 | Input | 32 | CJ1W-ID231 | XW2Z-□□□B 32-point Unit: 1 Cable 64-point Unit: 2 Cables |
| | | | 64 | CJ1W-ID261 | |
| O32C | C2 | Input | 32 | CJ1W-ID232 | XW2Z-□□□K 32-point Unit: 1 Cable 64-point Unit: 2 Cables |
| | | | 64 | CJ1W-ID262 | |
| | | Input/Output | 32 | CJ1W-MD263 (inputs) | |
| | | | 32 | CJ1W-MD563 (inputs) | |
| O32B | C3 | Output | 32 | CJ1W-OD231 | XW2Z-□□□B 32-point Unit: 1 Cable 64-point Unit: 2 Cables |
| | | | 64 | CJ1W-OD261 | |
| O32C | C4 | Output | 32 | CJ1W-MD261 (outputs) | XW2Z-□□□K 32-point Unit: 1 Cable 64-point Unit: 2 Cables |
| | | | | CJ1W-OD232 | |
| | | | | CJ1W-OD233 | |
| | | Output | 64 | CJ1W-OD234 | |
| | | | | CJ1W-OD262 | |
| | | Input/Output | 32 | CJ1W-OD263 | |
| | | | | CJ1W-MD263 (outputs) | |
| CJ1W-MD563 (outputs) | | | | | |

Note: 1. □□□ is replaced by the cable length.

2. There is one common for each 32 points.

Connector-terminal block conversion unit

| Product name | Specifications | I/O Points (number of poles) | Model |
|--|--|------------------------------|---------------|
| Connector-Terminal Block Conversion Unit | Push-In Plus  | 32 (36) | XW2K-40G-O32A |
| | | 32 (36) | XW2K-40G-O32B |
| | | 32 (36) | XW2K-40G-O32C |
| | Phillips screw  | 32 (34) | XW2R-J34GD-C1 |
| | | 32 (34) | XW2R-J34GD-C2 |
| | | 32 (34) | XW2R-J34GD-C3 |
| | | 32 (34) | XW2R-J34GD-C4 |
| | Slotted screw (rise up)  | 32 (34) | XW2R-E34GD-C1 |
| | | 32 (34) | XW2R-E34GD-C2 |
| | | 32 (34) | XW2R-E34GD-C3 |
| | | 32 (34) | XW2R-E34GD-C4 |

Connecting cables

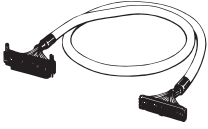
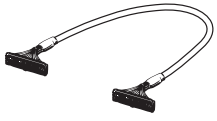
| Product name | Appearance | Connectors | Model | Cable length (m) |
|-------------------------------|--|--|-----------|------------------|
| For I/O Unit Connecting Cable | XW2Z-□□□B  | One 40-pin MIL Connector to One 40-pin Connector Made by Fujitsu Component, Ltd. | XW2Z-050B | 0.5 |
| | | | XW2Z-100B | 1 |
| | | | XW2Z-150B | 1.5 |
| | | | XW2Z-200B | 2 |
| | | | XW2Z-300B | 3 |
| | | | XW2Z-500B | 5 |
| | XW2Z-□□□K  | One 40-pin MIL Connector to One 40-pin MIL Connector | XW2Z-C50K | 0.5 |
| | | | XW2Z-100K | 1 |
| | | | XW2Z-150K | 1.5 |
| | | | XW2Z-200K | 2 |
| | | | XW2Z-300K | 3 |
| | | | XW2Z-500K | 5 |

■ Interrupt Input Units

| Unit classification | Product name | Specifications | | | | | | No. of words allocated | Current consumption (A) | | Model | Standards |
|---------------------|--|----------------|-----------------------|---------------------|--|-------------------------------|--------------------------|------------------------|-------------------------|------|------------|---------------|
| | | I/O points | Input voltage current | Commons | Input pulse width conditions | Max. Units mountable per Unit | External connection | | 5 V | 24 V | | |
| CJ1 Basic I/O Units | Interrupt Input Unit  | 16 inputs | 24 VDC, 7 mA | 16 points, 1 common | ON time: 0.05 ms max. OFF time: 0.5 ms max. | 2 | Removable terminal block | 1 word | 0.08 | --- | CJ1W-INT01 | UC1, N, L, CE |

Note 1. Can be used only on CPU Racks, and not on Expansion Racks.
Note 2. The locations where the Units can be mounted depend on the CPU Rack and the CPU Unit model.
 CJ2H-CPU6□-EIP: From the slot next to the CPU Unit until the fourth slot.
 CJ2H-CPU6□, CJ2M: From the slot next to the CPU Unit until the fifth slot.

■ Quick-response Input Units

| Unit classification | Product name | Specifications | | | | | No. of words allocated | Current consumption (A) | | Model | Standards |
|---------------------|--|----------------|------------------------------|---------------------|--|--------------------------|------------------------|-------------------------|------|------------|---------------|
| | | I/O points | Input voltage, Input current | Commons | Input pulse width conditions | External connection | | 5 V | 24 V | | |
| CJ1 Basic I/O Units | Quick-response Input Unit  | 16 inputs | 24 VDC, 7 mA | 16 points, 1 common | ON time: 0.05 ms max. OFF time: 0.5 ms max. | Removable terminal block | 1 word | 0.08 | --- | CJ1W-IDP01 | UC1, N, L, CE |

Note: There are no restrictions on the mounting position or number of Units.

Special I/O Units and CPU Bus Units

■ Process I/O Units

● Isolated-type Units with Universal Inputs

| Unit classification | Product name | Input points | Signal range selection | Signal range | Conversion speed (resolution) | Accuracy (at ambient temperature of 25°C) | External connection | No. of unit numbers allocated | Current consumption (A) | | Model | Standards |
|-----------------------|---|--------------|-------------------------------|---|---|--|--------------------------|-------------------------------|-------------------------|------|--------------------------|------------|
| | | | | | | | | | 5 V | 24 V | | |
| CJ1 Special I/O Units | Process Input Units (Isolated-type Units with Universal Inputs)  | 4 inputs | Set separately for each input | Universal inputs: Pt100 (3-wire), JPt100 (3-wire), Pt1000 (3-wire), Pt100 (4-wire), K, J, T, E, L, U, N, R, S, B, WRe5-26, PL II, 4 to 20 mA, 0 to 20 mA, 1 to 5 V, 0 to 1.25 V, 0 to 5 V, 0 to 10 V, ±100 mV selectable range -1.25 to 1.25 V, -5 to 5 V, -10 to 10 V, ±10 V selectable range, potentiometer | Resolution (conversion speed): 1/256,000 (conversion cycle: 60 ms/ 4 inputs) 1/64,000 (conversion cycle: 10 ms/ 4 inputs) 1/16,000 (conversion cycle: 5 ms/ 4 inputs) | Standard accuracy: ±0.05% of F.S. | Removable terminal block | 1 | 0.30 | --- | CJ1W-PH41U (See note 1.) | UC1, CE |
| | | 4 inputs | Set separately for each input | Universal inputs: Pt100, JPt100, Pt1000, K, J, T, L, R, S, B, 4 to 20 mA, 0 to 20 mA, 1 to 5 V, 0 to 5 V, 0 to 10 V | Conversion speed: 250 ms/ 4 inputs | Accuracy: Platinum resistance thermometer input: (±0.3% of PV or ±0.8°C, whichever is larger) ±1 digit max. Thermocouple input: (±0.3% of PV or ±1.5°C, whichever is larger) ±1 digit max. (See note 2.) Voltage or current input: ±0.3% of F.S. ±1 digit max. | | | 0.32 | --- | CJ1W-AD04U | UC1, L, CE |

Note 1. Do not connect a Relay Output Unit to the same CPU Rack or to the same Expansion Rack as the CJ1W-PH41U.

2. L and -100°C or less for K and T are ±2°C±1 digit max., and 200°C or less for R and S is ±3°C±1 digit max. No accuracy is specified for 400°C or less for B.

● Isolated-type Thermocouple Input Units

| Unit classification | Product name | Input points | Signal range selection | Signal range | Conversion speed (resolution) | Accuracy (at ambient temperature of 25°C) | External connection | No. of unit numbers allocated | Current consumption (A) | | Model | Standards |
|-----------------------|---|--------------|-----------------------------------|---|--|---|--------------------------|-------------------------------|-------------------------|--------------------|------------|-----------|
| | | | | | | | | | 5 V | 24 V | | |
| CJ1 Special I/O Units | Process Input Units (Isolated-type Thermocouple Input Units)  | 2 inputs | Set separately for each input | Thermocouple: B, E, J, K, L, N, R, S, T, U, WRe5-26, PLII DC voltage: ±100 mV | Conversion speed: 10 ms/ 2 inputs, Resolution: 1/64,000 | Standard accuracy: ±0.05% of F.S. (See note 1.) | Removable terminal block | 1 | 0.18 | 0.06 (See note 2.) | CJ1W-PTS15 | UC1 |
| | | 4 inputs | Thermocouple: R, S, K, J, T, L, B | Conversion speed: 250 ms/ 4 inputs | Accuracy: (±0.3% of PV or ±1°C, whichever is larger) ±1 digit max. (See note 3.) | 0.25 | | | --- | CJ1W-PTS51 | UC1, CE | |

Note 1. The accuracy depends on the sensors used and the measurement temperatures. For details, refer to the user's manual.

2. This is for an external power supply, and not for internal current consumption.

3. L and -100°C or less for K and T are ±2°C±1 digit max., and 200°C or less for R and S is ±3°C±1 digit max. No accuracy is specified for 400°C or less for B.

● Isolated-type Resistance Thermometer Input Units

| Unit classification | Product name | Input points | Signal range selection | Signal range | Conversion speed (resolution) | Accuracy (at ambient temperature of 25°C) | External connection | No. of unit numbers allocated | Current consumption (A) | | Model | Standards |
|-----------------------|--|--------------|------------------------|---------------------------------------|-----------------------------------|--|--------------------------|-------------------------------|-------------------------|------|------------|-----------|
| | | | | | | | | | 5 V | 24 V | | |
| CJ1 Special I/O Units | Process Analog Input Units (Isolated-type Resistance Thermometer Input Units)  | 4 inputs | Common inputs | Resistance thermometer: Pt100, JPt100 | Conversion speed: 250 ms/4 inputs | Accuracy: ±0.3°C of PV or ±0.8°C, whichever is larger, ±1 digit max. | Removable terminal block | 1 | 0.25 | --- | CJ1W-PTS52 | UC1, CE |
| | | | | | | | | | | | | |

Note: This is for an external power supply, and not for internal current consumption.



● Isolated-type DC Input Units

| Unit classification | Product name | Input points | Signal range selection | Conversion speed (resolution) | Accuracy (at ambient temperature of 25°C) | External connection | No. of unit numbers allocated | Current consumption (A) | | Model | Standards |
|-----------------------|--|--------------|---|--|---|--------------------------|-------------------------------|-------------------------|------------------|------------|-----------|
| | | | | | | | | 5 V | 24 V | | |
| CJ1 Special I/O Units | Isolated-type DC Input Units  | 2 inputs | DC voltage: 0 to 1.25 V, -1.25 to 1.25 V, 0 to 5 V, 1 to 5 V, -5 to 5 V, 0 to 10 V, -10 to 10 V, ±10 V selectable range DC current: 0 to 20 mA, 4 to 20 mA | Conversion speed: 10 ms/2 inputs Resolution: 1/64,000 | Standard accuracy: ±0.05% of F.S. | Removable terminal block | 1 | 0.18 | 0.09 (See note.) | CJ1W-PDC15 | UC1, CE |

Note: This is for an external power supply, and not for internal current consumption.

■ Analog I/O Units

● Analog Input Units

| Unit classification | Product name | Input points | Signal range selection | Signal range | Resolution | Conversion speed | Accuracy (at ambient temperature of 25°C) | External connection | No. of unit numbers allocated | Current consumption (A) | | Model | Standards |
|-----------------------|---|---|-------------------------------|--|--|---|--|--|-------------------------------|-------------------------|---------------|---------------|---------------|
| | | | | | | | | | | 5 V | 24 V | | |
| CJ1 Special I/O Units | Analog Input Units <i>High-speed type</i>  | 4 inputs | Set separately for each input | 1 to 5 V (1/10,000), 0 to 10 V (1/20,000), -5 to 5 V (1/20,000), -10 to 10 V (1/40,000), and 4 to 20 mA (1/10,000) | | 20 μs/1 point, 25 μs/2 points, 30 μs/3 points, 35 μs/4 points The Direct conversion is provided. | Voltage: ±0.2% of F.S. Current: ±0.4% of F.S. | Removable terminal block | 1 | 0.52 | --- | CJ1W-AD042 | UC1, CE |
| | | | | | | | | | | | | | |
| | | Analog Input Units  | 8 inputs | | 1 to 5 V, 0 to 5 V, 0 to 10 V, -10 to 10 V, 4 to 20 mA | 1/4000, (Settable to 1/8000) (See note 1.) | 1 ms/point max. (Settable to 250 μs/point) (See note 1.) | Voltage: ±0.2% of F.S. Current: ±0.4% of F.S. (See note 2.) | | 0.42 | --- | CJ1W-AD081-V1 | UC1, N, L, CE |
| | | 4 inputs | | | | | | | 0.42 | --- | CJ1W-AD041-V1 | | |

Note 1. The resolution and conversion speed cannot be set independently. If the resolution is set to 1/4,000, then the conversion speed will be 1 ms/point.
2. At 23 ±2°C

● Analog Output Units

| Unit classification | Product name | Output points | Signal range selection | Signal range | Resolution | Conversion speed | Accuracy (at ambient temperature of 25°C) | External connection | External power supply | No. of unit numbers allocated | Current consumption (A) | | Model | Standards |
|-----------------------|---|--|-------------------------------|--|--|---|---|---------------------|-----------------------|---|---|---|---------------------|---------------------|
| | | | | | | | | | | | 5 V | 24 V | | |
| CJ1 Special I/O Units | Analog Output Units  | 4 outputs | Set separately for each input | 1 to 5 V (1/10,000), 0 to 10 V (1/20,000), and -10 to 10 V (1/40,000) | 20 μs/ 1 point, 25 μs/ 2 points, 30 μs/ 3 points, 35 μs/ 4 points The Direct conversion is provided. | ±0.3% of F.S. | Removable terminal block | --- | 1 | 0.40 | --- | CJ1W-DA042V | UC1, CE | |
| | | 8 outputs | | | | | | | | 1 to 5 V, 0 to 5 V, 0 to 10 V, -10 to 10 V | 1 ms/ point max. (Settable to 250 μs/point) | 24 VDC +10% -15% , 140 mA max. | 0.14 | 0.14 (See note.) |
| | 8 outputs | 4 to 20 mA | | 1/4,000 (Settable to 1/8,000) | 24 VDC +10% -15% , 170 mA max. | 0.14 | | 0.17 (See note.) | CJ1W-DA08C | UC1, N, CE | | | | |
| | 4 outputs | 1 to 5 V, 0 to 5 V, 0 to 10 V, -10 to 10 V, 4 to 20 mA | | 1/4000 | 1 ms/ point max. | 24 VDC +10% -15% , 200 mA max. | | 0.12 | 0.2 (See note.) | CJ1W-DA041 | UC1, N, L, CE | | | |
| | 2 outputs | | | | | | | | | 24 VDC +10% -15% , 140 mA max. | | 0.12 | 0.14 (See note.) | CJ1W-DA021 |

Note: This is for an external power supply, and not for internal current consumption

● Analog I/O Units

| Unit classification | Product name | No. of points | Signal range selection | Signal range | Resolution (See note.) | Conversion speed (See note.) | Accuracy (at ambient temperature of 25°C) | External connection | No. of unit numbers allocated | Current consumption (A) | | Model | Standards |
|-----------------------|--|---------------|-------------------------------|--|-------------------------------|--|--|--------------------------|-------------------------------|-------------------------|------|------------|---------------|
| | | | | | | | | | | 5 V | 24 V | | |
| CJ1 Special I/O Units | Analog I/O Units  | 4 inputs | Set separately for each input | 1 to 5 V, 0 to 5 V, 0 to 10 V, -10 to 10 V, 4 to 20 mA | 1/4,000 (Settable to 1/8,000) | 1 ms/point (Settable to 500 μs/point max.) | Voltage input: ±0.2% of F.S. Current input: ±0.2% of F.S. Voltage output: ±0.3% of F.S. Current output: ±0.3% of F.S. | Removable terminal block | 1 | 0.58 | --- | CJ1W-MAD42 | UC1, N, L, CE |
| | 2 outputs | | | | | | | | | | | | |

Note: The resolution and conversion speed cannot be set independently. If the resolution is set to 1/4,000, then the conversion speed will be 1 ms/point.

■ Temperature Control Units

| Unit classification | Product name | Specifications | | | No. of unit numbers allocated | Current consumption (A) | | Model | Standards |
|-----------------------|--|--|---|-------------------------------------|-------------------------------|-------------------------|------|------------|---------------|
| | | No. of loops | Temperature sensor inputs | Control outputs | | 5 V | 24 V | | |
| CJ1 Special I/O Units | Temperature Control Units  | 4 loops | Thermocouple input (R, S, K, J, T, B, L) | Open collector NPN outputs (pulses) | 2 | 0.25 | --- | CJ1W-TC001 | UC1, N, L, CE |
| | | 4 loops | | Open collector PNP outputs (pulses) | | 0.25 | --- | CJ1W-TC002 | |
| | | 2 loops, heater burnout detection function | | Open collector NPN outputs (pulses) | | 0.25 | --- | CJ1W-TC003 | |
| | | 2 loops, heater burnout detection function | | Open collector PNP outputs (pulses) | | 0.25 | --- | CJ1W-TC004 | |
| | | 4 loops | Platinum resistance thermometer input (JPt100, Pt100) | Open collector NPN outputs (pulses) | | 0.25 | --- | CJ1W-TC101 | |
| | | 4 loops | | Open collector PNP outputs (pulses) | | 0.25 | --- | CJ1W-TC102 | |
| | | 2 loops, heater burnout detection function | | Open collector NPN outputs (pulses) | | 0.25 | --- | CJ1W-TC103 | |
| | | 2 loops, heater burnout detection function | | Open collector PNP outputs (pulses) | | 0.25 | --- | CJ1W-TC104 | |

■ High-speed Counter Unit

| Unit classification | Product name | Specifications | | | No. of unit numbers allocated | Current consumption (A) | | Model | Standards |
|-----------------------|--|--------------------|--|--------------------|-------------------------------|-------------------------|------|--------------|---------------|
| | | Countable channels | Encoder A and B inputs, pulse input Z signals | Max. counting rate | | 5 V | 24 V | | |
| CJ1 Special I/O Units | High-speed Counter Unit  | 2 | Open collector Input voltage: 5 VDC, 12 V, or 24 V (5 V and 12 V are each for one axis only.) | 50 kHz | 4 | 0.28 | --- | CJ1W-CT021 * | UC1, N, L, CE |
| | | | RS-422 line driver | 500 kHz | | | | | |

* Use Lot No.030121 or later (Unit Version 1.06) of CJ1W-CT021 when using with CJ2 CPU Units.

■ Position Control Units

● Position Control Units (High-speed type)

| Unit classification | Product name | Specifications | | No. of unit numbers allocated | Current consumption (A) | | Model | Standards | | |
|-----------------------|--|---|----------------------|--|-------------------------|--------|-------------------|------------|---------------|-----|
| | | | | | 5 V | 24 V | | | | |
| | | Control output interface | | No. of axes | | | | | | |
| CJ1 Special I/O Units | Position Control Units <small>High-speed type</small> | Pulse-train open-collector output with Pulse Counter Function | | 2 axes | 2 | 0.27 | --- | CJ1W-NC214 | UL1, CE | |
| | | | | 4 axes | | 0.31 | --- | CJ1W-NC414 | | |
| | | Pulse-train line-driver output with Pulse Counter Function | | 2 axes | 2 | 0.27 | --- | CJ1W-NC234 | | |
| | | | | 4 axes | | 0.31 | --- | CJ1W-NC434 | | |
| | Position Control Unit Cables | Open-collector output | For CJ1W-NC214/NC414 | Connecting Servo Drives: G Series R88D-GT G5 Series R88D-KT | | 1 axis | Cable length: 1 m | | XW2Z-100J-G13 | --- |
| | | | | | | | Cable length: 3 m | | XW2Z-300J-G13 | |
| | | | | Connecting Servo Drives: SMARTSTEP2 R7D-BP | | | Cable length: 1 m | | XW2Z-100J-G14 | |
| | | | | | | | Cable length: 3 m | | XW2Z-300J-G14 | |
| | | | | Connecting Servo Drives: G Series R88D-GT G5 Series R88D-KT | | 2 axes | Cable length: 1 m | | XW2Z-100J-G5 | |
| | | | | | | | Cable length: 3 m | | XW2Z-300J-G5 | |
| | | | | Connecting Servo Drives: SMARTSTEP2 R7D-BP | | | Cable length: 1 m | | XW2Z-100J-G6 | |
| | | | | | | | Cable length: 3 m | | XW2Z-300J-G6 | |
| | | Line-driver output | For CJ1W-NC234/NC434 | Connecting Servo Drives: G Series R88D-GT G5 Series R88D-KT | | 1 axis | Cable length: 1 m | | XW2Z-100J-G9 | |
| | | | | | | | Cable length: 5 m | | XW2Z-500J-G9 | |
| | | | | Cable length: 10 m | | | XW2Z-10MJ-G9 | | | |
| | | | | Cable length: 1 m | | | XW2Z-100J-G12 | | | |
| | | | | Cable length: 5 m | | | XW2Z-500J-G12 | | | |
| | | | | Cable length: 10 m | | | XW2Z-10MJ-G12 | | | |
| | | | | Applicable Servo Drive: G Series R88D-GT G5 Series R88D-KT | | 2 axes | Cable length: 1 m | | XW2Z-100J-G1 | |
| | | | | | | | Cable length: 5 m | | XW2Z-500J-G1 | |
| Cable length: 10 m | | XW2Z-10MJ-G1 | | | | | | | | |
| Cable length: 1 m | | XW2Z-100J-G4 | | | | | | | | |
| Cable length: 5 m | | XW2Z-500J-G4 | | | | | | | | |
| Cable length: 10 m | | XW2Z-10MJ-G4 | | | | | | | | |

● Position Control Units

| Unit classification | Product name | Specifications | | | No. of unit numbers allocated | Current consumption (A) | | Model | Standards | |
|-----------------------|--|--|--|--|-------------------------------|-------------------------|---------------------|---------------|---------------|-----|
| | | Control output interface | | No. of axes | | 5 V | 24 V | | | |
| CJ1 Special I/O Units | Position Control Units  | Pulse train, open collector output | | 1 axis | 1 | 0.25 | --- | CJ1W-NC113 | UC1, CE | |
| | | Pulse train, open collector output | | 2 axes | | 0.25 | --- | CJ1W-NC213 | | |
| | | Pulse train, open collector output (See note.) | | 4 axes | 2 | 0.36 | --- | CJ1W-NC413 | | |
| | | Pulse train, line driver output | | 1 axis | | 0.25 | --- | CJ1W-NC133 | | |
| | | Pulse train, line driver output | | 2 axes | 1 | 0.25 | --- | CJ1W-NC233 | | |
| | | Pulse train, line driver output (See note.) | | 4 axes | | 0.36 | --- | CJ1W-NC433 | | |
| | Space Unit | Use a CJ1W-SP001 Space Unit if the operating temperature is 0 to 55°C. | | | | | | CJ1W-SP001 | UC1, CE | |
| | Servo Relay Units | For 1-Axis Position Control Unit (without communications support) (CJ1W-CN113/133) | | | | | | XW2B-20J6-1B | --- | |
| | | For 2- or 4-Axes Position Control Unit (without communications support) (CJ1W-NC213/233/413/433) | | | | | | XW2B-40J6-2B | | |
| | | For 2- or 4-Axes Position Control Unit (with communications support) (CJ1W-NC213/233/413/433) | | | | | | XW2B-40J6-4A | | |
| | Position Control Unit Cables | Open-collector output | For CJ1W-NC113 | Connecting Servo Drives: G5/G Series, SMARTSTEP2 | | 1 axis | Cable length: 0.5 m | | XW2Z-050J-A14 | --- |
| | | | | Connecting Servo Drives: G5/G Series, SMARTSTEP2 | | | Cable length: 1 m | | XW2Z-100J-A14 | |
| | | | For CJ1W-NC213/413 | Connecting Servo Drives: G5/G Series, SMARTSTEP2 | | 2 axes | Cable length: 0.5 m | | XW2Z-050J-A15 | |
| | | | | Connecting Servo Drives: G5/G Series, SMARTSTEP2 | | | Cable length: 1 m | | XW2Z-100J-A15 | |
| Line-driver output | | For CJ1W-NC133 | Connecting Servo Drives: G5/G Series, SMARTSTEP2 | | 1 axis | Cable length: 0.5 m | | XW2Z-050J-A18 | | |
| | | | Connecting Servo Drives: G5/G Series, SMARTSTEP2 | | | Cable length: 1 m | | XW2Z-100J-A18 | | |
| | | For CJ1W-NC233/433 | Connecting Servo Drives: G5/G Series, SMARTSTEP2 | | 2 axes | Cable length: 0.5 m | | XW2Z-050J-A19 | | |
| | | | Connecting Servo Drives: G5/G Series, SMARTSTEP2 | | | Cable length: 1 m | | XW2Z-100J-A19 | | |

Note: The ambient operating temperature for 4-Axes Position Control Units is 0 to 50°C; the allowable voltage fluctuation on the external 24-VDC power supply is 22.8 to 25.2 VDC (24 V ±5%).

■ Position Control Unit with EtherCAT interface

| Unit classification | Product name | Specifications | | No. of unit numbers allocated | Current consumption (A) | | Model | Standards |
|---------------------|--|--|-------------|-------------------------------|-------------------------|------|------------|-----------|
| | | Control output interface | No. of axes | | 5 V | 24 V | | |
| CJ1 CPU Bus Units | Position Control Unit with EtherCAT interface  | Control commands executed by EtherCAT communications. Positioning functions: Memory operation, Direct operation by ladder programming | 2 axes | 1 | 0.46 | --- | CJ1W-NC281 | UC1, CE |
| | | | 4 axes | | | | CJ1W-NC481 | |
| | | | 8 axes | | | | CJ1W-NC881 | |
| | | | 16 axes | | | | CJ1W-NCF81 | |
| | | Control commands executed by EtherCAT communications. • Positioning functions: Memory operation, Direct operation by ladder programming • I/O communication : 64 nodes | 4 axes | 1 | 0.46 | --- | CJ1W-NC482 | |
| | | | 8 axes | | | | CJ1W-NC882 | |
| 16 axes | CJ1W-NCF82 | | | | | | | |

Note: Use Category 5 or higher cables with double shield of aluminium tape and braid shield for connection with EtherCAT Slaves. We also recommend you to use Category 5 or higher modular connectors.

■ EtherCAT Slave Unit



| Unit type | Product name | Specifications | | No. of unit numbers allocated | Current consumption (A) | | Model | Standards |
|------------------|---|---|--|-------------------------------|-------------------------|------|------------|-----------|
| | | Communications cable | Communications functions | | 5 V | 24 V | | |
| CJ1 CPU Bus Unit | EtherCAT Slave Unit  | STP (shielded twisted-pair) cable of category 5 or higher with double shielding | Refreshing methods: Free-Run Mode PDO data sizes: TxPDO 400byte max./ RxPDO: 400byte max. | 1 | 0.34 | --- | CJ1W-ECT21 | UC1,CE,KC |

● Recommended EtherCAT Communications Cables

Category 5 or higher (100BASE-TX) straight cable with double shielding (aluminum tape and braided shielding) is recommended.

Cabel with Connectors

Wire Gauge and Number of Pairs: AWG22, 2-pair Cable

| Item | Appearance | Recommended manufacturer | Cable length(m) | Model |
|--|---|--------------------------|-----------------|-----------------|
| Cable with Connectors on Both Ends (RJ45/RJ45) |  | OMRON | 0.3 | XS5W-T421-AMD-K |
| | | | 0.5 | XS5W-T421-BMD-K |
| | | | 1 | XS5W-T421-CMD-K |
| | | | 2 | XS5W-T421-DMD-K |
| | | | 5 | XS5W-T421-GMD-K |
| | | | 10 | XS5W-T421-JMD-K |
| Cable with Connectors on Both Ends (M12/RJ45) |  | OMRON | 0.3 | XS5W-T421-AMC-K |
| | | | 0.5 | XS5W-T421-BMC-K |
| | | | 1 | XS5W-T421-CMC-K |
| | | | 2 | XS5W-T421-DMC-K |
| | | | 5 | XS5W-T421-GMC-K |
| | | | 10 | XS5W-T421-JMC-K |

Note: The cable length 0.3, 0.5, 1, 2, 3, 5, 10 and 15m are available. For details, refer to Cat.No.G019.

Cables / Connectors

Wire Gauge and Number of Pairs: AWG24, 4-pair Cable

| Item | Appearance | Recommended manufacturer | Model |
|-----------------|------------|----------------------------|-----------------------------|
| Cables | --- | Tonichi Kyosan Cable, Ltd. | NETSTAR-C5E SAB 0.5 × 4P CP |
| | --- | Kuramo Electric Co. | KETH-SB |
| RJ45 Connectors | --- | Panduit Corporation | MPS588 |

Wire Gauge and Number of Pairs: AWG22, 2-pair Cable





| Item | Appearance | Recommended manufacturer | Model |
|-------------------------|---|--------------------------|----------------|
| Cables | --- | Kuramo Electric Co. | KETH-PSB-OMR * |
| RJ45 Assembly Connector |  | OMRON | XS6G-T421-1 * |

* We recommend you to use above cable and connector together.

■ Position Control Unit with MECHATROLINK-II interface

| Unit classification | Product name | Specifications | | No. of unit numbers allocated | Current consumption (A) | | Model | Standards |
|---------------------------------------|---|---|--|-------------------------------|-------------------------|--------------|---------------|-----------|
| | | Control output interface | No. of axes | | 5 V | 24 V | | |
| CJ1 CPU Bus Units | Position Control Unit with MECHATROLINK-II interface  | Control commands executed by MECHATROLINK-II synchronous communications. Direct operation by ladder programming. Control mode: Position control, speed control, or torque control | 2 axes | 1 | 0.36 | --- | CJ1W-NC271 | UC1, CE |
| | | | 4 axes | | | | CJ1W-NC471 | |
| | | | 16 axes | | | | CJ1W-NCF71 | |
| | | | 16 axes | | | | CJ1W-NCF71-MA | |
| | | | | | | | | |
| | MECHATROLINK-II Cables | MECHATROLINK-II Cables (without ring core and USB connector on both ends) Note: Can be connected to R88D-GN and R88D-KN only. | Cable length: 0.5 m | | FNY-W6002-A5 | --- | | |
| | | | Cable length: 1 m | | FNY-W6002-01 | | | |
| | | | Cable length: 3 m | | FNY-W6002-03 | | | |
| | | | Cable length: 5 m | | FNY-W6002-05 | | | |
| | | | MECHATROLINK-II Cables (with ring core and USB connector on both ends) (Yaskawa Electric Corporation) Use the model numbers provided in this catalog when ordering from OMRON. | Cable length: 0.5 m | | FNY-W6003-A5 | --- | |
| | | | | Cable length: 1 m | | FNY-W6003-01 | | |
| | | | | Cable length: 3 m | | FNY-W6003-03 | | |
| | | | | Cable length: 5 m | | FNY-W6003-05 | | |
| | | | | Cable length: 10 m | | FNY-W6003-10 | | |
| | | | | Cable length: 20 m | | FNY-W6003-20 | | |
| Cable length: 30 m | | FNY-W6003-30 | | | | | | |
| MECHATROLINK-II Terminating Resistors | Terminating Resistor for MECHATROLINK-II (Yaskawa Electric Corporation) Use the model numbers provided in this catalog when ordering from OMRON. | | FNY-W6022 | --- | | | | |
| MECHATROLINK-II Repeater | Repeater (Yaskawa Electric Corporation) | | JEPMC-REP2000-E | --- | | | | |

Serial Communications Units

| Unit classification | Product name | Specifications | | No. of unit numbers allocated | Current consumption (A) | | Model | Standards |
|---------------------|--|---------------------------------------|---|-------------------------------|-------------------------|------|------------|---------------|
| | | Communications Interface | Communications functions | | 5 V | 24 V | | |
| CJ1 CPU Bus Units | Serial Communications Units     | 2 RS-232C ports | The following functions can be selected for each port: Protocol macro Host Link NT Links (1:N mode) Serial Gateway No-protocol Modbus-RTU Slave | 1 | 0.29 (See note.) | --- | CJ1W-SCU22 | UC1, N, L, CE |
| | | 2 RS-422A/485 ports | | | 0.46 | --- | CJ1W-SCU32 | |
| | | 1 RS-232C port and 1 RS-422A/485 port | | | 0.38 (See note.) | --- | CJ1W-SCU42 | |

Note: When an NT-AL001 RS-232C/RS-422A Conversion Unit is used, this value increases by 0.15 A/Unit. Add 0.20A/Unit when using NV3W-M□20L(-V1) Programmable Terminals. Add 0.04A/Unit when using CJ1W-CIF11 RS-422A Adapters.

EtherNet/IP Unit

| Unit classification | Product name | Specifications | | | No. of unit numbers allocated | Current consumption (A) | | Model | Standards |
|---------------------|--|---|---|----------------------------------|-------------------------------|-------------------------|------|-------------|---------------|
| | | Communications cable | Communications functions | Max.Units mountable per CPU Unit | | 5 V | 24 V | | |
| CJ1 CPU Bus Unit | EtherNet/IP Unit  | STP (shielded twisted-pair) cable of category 5, 5e, or higher. | Tag data link Message communications | 8 (See note.) | 1 | 0.41 | --- | CJ1W-EIP21 | UC1, N, L, CE |
| | | | Tag data link Message communications Socket service | | | 0.65 | --- | CJ1W-EIP21S | |

Note: Up to seven EtherNet/IP Units can be connected to a CJ2H-CPU□□-EIP. Up to two EtherNet/IP Units can be connected to a CJ2M CPU Unit.

Ethernet Unit

| Unit classification | Product name | Specifications | | | No. of unit numbers allocated | Current consumption (A) | | Model | Standards |
|---------------------|---|----------------------|--|----------------------------------|-------------------------------|-------------------------|------|------------|---------------|
| | | Communications cable | Communications functions | Max.Units mountable per CPU Unit | | 5 V | 24 V | | |
| CJ1 CPU Bus Unit | Ethernet Unit  | 100Base-TX | FINS communications service (TCP/IP, UDP/IP), FTP server functions, socket services, mail transmission service, mail reception (remote command receive), automatic adjustment of PLC's built-in clock, server/host name specifications | 4 | 1 | 0.37 | --- | CJ1W-ETN21 | UC1, N, L, CE |

● Industrial Switching Hubs

| Product name | Appearance | Functions | No. of ports | Accessories | Current consumption (A) | Model |
|---------------------------|---|---|--------------|------------------------|-------------------------|----------|
| Industrial Switching Hubs |  | Quality of Service (QoS): EtherNet/IP control data priority 10/100BASE-TX, Auto-Negotiation | 5 | Power supply connector | 0.07 | W4S1-05D |

● WE70 FA WIRELESS LAN UNITS

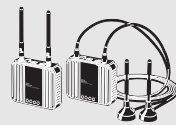
| Product name | Applicable region | Type | Model | Standards |
|---|-----------------------|-----------------------|--------------|-----------|
|  | Japan | Access Point (Master) | WE70-AP | --- |
| | | Client (Slave) | WE70-CL | |
| | Europe | Access Point (Master) | WE70-AP-EU | CE |
| | | Client (Slave) | WE70-CL-EU | |
| | Canada | Access Point (Master) | WE70-AP-CA * | UC |
| | | Client (Slave) | WE70-CL-CA * | |
| China | Access Point (Master) | WE70-AP-CN | --- | |
| | Client (Slave) | WE70-CL-CN | | |

- Note 1.** A Pencil Antenna, mounting magnet, and screw mounting bracket are included as accessories.
2. Always use a model that is applicable in your region. Refer to the *WE70 Catalog* (Cat. No. N154).
3. Final order entry date: The end of June, 2020.

* From January 2016, the WE70-AP-CA and WE70-CL-CA can be used in Singapore.

■ Controller Link Units

● Controller Link Units

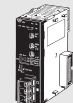
| Unit classification | Product name | Specifications | | | | No. of unit numbers allocated | Current consumption (A) | | Model | Standards |
|---------------------|---|---|--------------------------------|----------------|-----------------------------------|-------------------------------|-------------------------|------|------------|---------------|
| | | Communications cable | Communications type | Duplex support | Max. Units mountable per CPU Unit | | 5 V | 24 V | | |
| CJ1 CPU Bus Unit |  Controller Link Unit | Wired shielded twisted-pair cable (See note.) | Data links and message service | No | 8 | 1 | 0.35 | --- | CJ1W-CLK23 | UC1, N, L, CE |

- Note:** Use the following special cable for shielded, twisted-pair cable.
- ESVC0.5 × 2C-13262 (Bando Electric Wire: Japanese Company)
 - ESNC0.5 × 2C-99-087B (JMACS Japan Co., Ltd.: Japanese Company)
 - ESPC 1P × 0.5 mm² (Nagaoka Electric Wire Co., Ltd.: Japanese Company)
 - Li2Y-FCY2 × 0.56qmm (Kromberg & Schubert, Komtec Department: German Company)
 - 1 × 2 × AWG-20PE+Tr.CUSN+PVC (Draka Cables Industrial: Spanish Company)
 - #9207 (Belden: US Company)

● Controller Link Support Boards

| Unit classification | Specification | | Accessories | Model | Standards |
|--|-----------------------------------|-------------------------------|---|---------------|-----------|
| | Communications cable | Communications type | | | |
|  Controller Link Support Board for PCI Bus | Wired shielded twisted-pair cable | Data link and message service | <ul style="list-style-type: none"> • CD-ROM × 1 (See note.) • INSTALLATION GUIDE (W467) × 1 • Communications connector × 1 | 3G8F7-CLK23-E | CE, KC |

- Note:** The CD-ROM contains FinsGateway Version 2003 (PCI-CLK Edition) and FinsGateway Version 3 (PCI-CLK Edition).
 Install the software from CD Ver 3.10 or higher if the operating system is Windows 7 (32bit) or Windows Vista.
 Install FinsGateway version 3 if the operating system is Windows NT 4.0 (Service pack 3 or higher), Windows ME, or Windows 98SE.

● Repeater Units

| Unit classification | Specifications | Model | Standards |
|---|---|------------|-----------|
| Controller Link Repeater Unit  | Wire-to-wire Model | CS1W-RPT01 | UC1, CE |
| | Wire-to-Optical (H-PCF) Model (See note 2.) | CS1W-RPT02 | |
| | Wire-to-Optical (GI) Model (See note 3.) | CS1W-RPT03 | |

Note 1. Using Repeater Units enables T-branches and long-distance wiring for Wired Controller Link networks. 62-node configurations, and converting part of the network to optical cable.



- When using wire-to-optical (H-PCF) cable, use a H-PCF cable (for both Controller Link and SYSMAC LINK) or a H-PCF optical fiber cable with connector.
- When using wire-to-optical (GI) cable, use a GI optical cable (for Controller Link).

● Relay Terminal Block

| Unit classification | Specifications | Model | Standards |
|---|---|------------|-----------|
| Relay Terminal Block for Wired Controller Link Unit  | Use for Wired Controller Link Units (set of 5). | CJ1W-TB101 | --- |

Note: Controller Link Units can be replaced without stopping the communications of the entire network if a Relay Terminal Block is installed in advance on the Unit in a Wired Controller Link network. Relay Blocks cannot be used on Controller Link Support Boards.

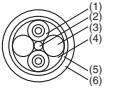
● H-PCF Cables and Optical Connectors

| Name | Application/construction | | Specifications | Model | Standards | |
|--|--------------------------------------|---|--|-----------------|---------------|-----|
| Optical Fiber Cables | Controller Link, SYSMAC LINK, SYSBUS |  (1) Optical fiber single-core cord (2) Tension member (plastic-sheathed wire) (3) Filler (plastic) (4) Filler surrounding signal wires (plastic, yarn, or fiber) (5) Holding tape (plastic) (6) Heat-resistant PV sheath | Two-core optical cable with tension member | Black * 10 m | S3200-HCCB101 | --- |
| | | | | Black * 50 m | S3200-HCCB501 | |
| | | | | Black * 100 m | S3200-HCCB102 | |
| | | | | Black * 500 m | S3200-HCCB502 | |
| | | | | Black * 1,000 m | S3200-HCCB103 | |
| Optical Connectors (Crimp-cut)  | CS1W-RPT02 | | Half lock | S3200-COCF2571 | --- | |
| | | | Full lock | S3200-COCF2071 | | |

* Orange specifications are Discontinuation.

● **H-PCF Optical Fiber Cables with Connectors (Black Composite Cables with Two-Optical Lines and Two Power Supply Lines)**

| Application | Appearance | Model | Standards |
|------------------------------|------------|--------------------|-----------|
| Controller Link, SYSMAC Link | | S3200-CN□□□□-20-20 | --- |
| | | S3200-CN□□□□-20-25 | |
| | | S3200-CN□□□□-25-25 | |

● **Cable Length**

The following cable lengths are available: 2 m, 5 m, 15 m, 20 m. For lengths of 21 m or more, contact your OMRON sales representative.

● **Model Numbers**

Lengths of 2 m, 5 m, 10 m, 15 m, and 20 m

Example: S3200-CN□□□□-20-25

Length of 21 m or more

Example: S3200-CN-20-20

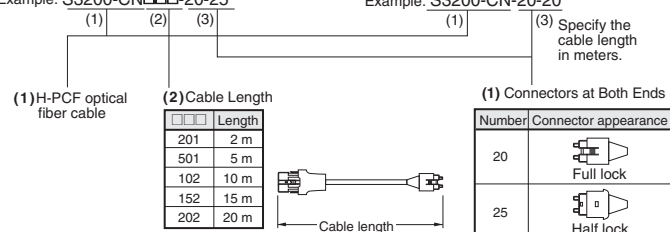

● **Optical Connector Assembly Tool**

| Name | Applicable Unit | Model | Manufacturer | Standards |
|---|---|----------|------------------------------------|-----------|
| Optical Fiber Assembly Tool (See note.) | This tool is used on site for mounting crimp-cut connectors and hard plastic-clad silica optical fiber for optical transmission systems of C-series SYSBUS, SYSMAC LINK, and Controller Link. | CAK-0057 | Sumitomo Electric Industries, Ltd. | --- |

Note: There is a risk of quality problems when using cables assembled by typical users, so we recommend purchasing cables with preattached connectors or having a qualified technician assemble the cables. Optical connectors for H-PCF Optical Cables with Connectors are adhesive polished.

● **GI Optical Cables**

A qualified technician must select, assemble, and install GI Optical Fiber Cable, so always let an optical cable specialist handle the GI cable.

Usable Optical Cables and Optical Connectors

- Optical fiber types: Graded, indexed, multi-mode, all quartz glass, fiber (GI-type AGF cable)
- Optical fiber construction (core diameter/clad diameter): 62.5/125 μm or 50/125 μm
- Optical fiber optical characteristics of optical fiber: Refer to the tables.
- Optical connector: ST connector (IEC-874-10)

● **50/125 μm AGF Cable**

| Item | Minimum | Standard | Maximum | Remarks | |
|---------------------------------|---------|----------|--------------|--------------------------|-------------------------|
| Numerical Aperture (N.A) | --- | 0.21 | --- | --- | |
| Transmission loss (dB) | --- | --- | 3.0 Lf | 0.5 km ≤ Lf | λ = 0.8 μm Ta = 25°C |
| | | | 3.0 Lf + 0.2 | 0.2 km ≤ Lf ≤ 0.5 km | |
| | | | 3.0 Lf + 0.4 | Lf ≤ 0.2 km | |
| Connection loss (dB) | --- | --- | 1.0 | λ = 0.8 μm, one location | |
| Transmission bandwidth (MHz-km) | 500 | --- | --- | λ = 0.85 μm (LD) | |

Lf is fiber length in km, Ta is ambient temperature, and λ: is the peak wavelength of the test light source.

● **62.5/125 μm AGF Cable**

| Item | Minimum | Standard | Maximum | Remarks | |
|---------------------------------|---------|----------|--------------|--------------------------|-------------------------|
| Numerical Aperture (N.A) | --- | 0.28 | --- | --- | |
| Transmission loss (dB) | --- | --- | 3.5 Lf | 0.5 km ≤ Lf | λ = 0.8 μm Ta = 25°C |
| | | | 3.5 Lf + 0.2 | 0.2 km ≤ Lf ≤ 0.5 km | |
| | | | 3.5 Lf + 0.4 | Lf ≤ 0.2 km | |
| Connection loss (dB) | --- | --- | 1.0 | λ = 0.8 μm, one location | |
| Transmission bandwidth (MHz-km) | 200 | --- | --- | λ = 0.85 μm (LD) | |

Lf is fiber length in km, Ta is ambient temperature, and λ is the peak wavelength of the test light source.

■ FL-net Unit

| Unit classification | Product name | Specifications | | | No. of unit numbers allocated | Current consumption (A) | | Model | Standards |
|---------------------|---|--------------------------|---|------------------------------------|-------------------------------|-------------------------|------|------------|-----------|
| | | Communications interface | Communications functions | Max. Units mountable per CPU Units | | 5 V | 24 V | | |
| CJ1 CPU Bus Units |  FL-net Unit | 100Base-TX | With FL-net Ver. 2.0 specifications (OPCN-2) Data links and message service | 4 | 1 | 0.37 | --- | CJ1W-FLN22 | UC1, CE |

■ DeviceNet Unit

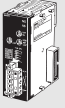
| Unit classification | Product name | Specifications | Communications type | No. of unit numbers allocated | Current consumption (A) | | Model | Standards |
|---------------------|--|--|---|-------------------------------|-------------------------|------|------------|---------------|
| | | | | | 5 V | 24 V | | |
| CJ1 CPU Bus Units |  DeviceNet Unit | Functions as master and/or slave; allows control of 32,000 points max. per master. | <ul style="list-style-type: none"> Remote I/O communications master (fixed or user-set allocations) Remote I/O communications slave (fixed or user-set allocations) Message communications | 1 | 0.29 | --- | CJ1W-DRM21 | UC1, N, L, CE |

■ CompoNet Master Unit

| Unit classification | Product name | Specifications | | No. of unit numbers allocated | Current consumption (A) | | Model | Standards |
|-----------------------|--|---|---|-------------------------------|-------------------------|------|------------|-----------------|
| | | Communications functions | No. of I/O points per Master Unit | | 5 V | 24 V | | |
| CJ1 Special I/O Units |  CompoNet Master Unit | <ul style="list-style-type: none"> Remote I/O communications Message communications | Word Slaves: 2,048 max. (1,024 inputs and 1,024 outputs) Bit Slaves: 512 max. (256 inputs and 256 outputs) | 1, 2, 4, or 8 | 0.4 | --- | CJ1W-CRM21 | U, U1, N, L, CE |

■ ID Sensor Units

| Unit classification | Product name | Specifications | | | No. of unit numbers allocated | Current consumption (A) | | Model | Standards |
|---------------------|---|-------------------------|----------------------------|-----------------------|-------------------------------|-------------------------|------------------|--------------|-----------|
| | | Connected ID Systems | No. of connected R/W heads | External power supply | | 5 V | 24 V | | |
| CJ1 CPU Bus Units |  ID Sensor Units | V680 Series RFID System | 1 | Not required. | 1 | 0.26 | 0.13 (See note.) | CJ1W-V680C11 | UC, CE |
| | | | 2 | | 2 | 0.32 | 0.26 | CJ1W-V680C12 | |
| | | V600 Series RFID System | 1 | Not required. | 1 | 0.26 | 0.12 | CJ1W-V600C11 | |
| | | | 2 | | 2 | 0.32 | 0.24 | CJ1W-V600C12 | |

Note: To use a V680-H01 Antenna, refer to the V680 Series RFID System Catalog (Cat. No. Q151).

■SPU Unit (High-speed Data Storage Unit)

| Unit classification | Product name | Specifications | | No. of unit numbers allocated | Current consumption (A) | | Model | Standards |
|---------------------|--|---|------------------------|-------------------------------|--|------------------|---------------|-----------|
| | | PC Card slot | Ethernet (LAN) port | | 5 V | 24 V | | |
| CJ1 CPU Bus Units | SPU Unit (High-speed Data Storage Unit) | CF Card Type I/II × 1 slot Use an OMRON HMC-EF□□□ Memory Card. | 1 port (10/100Base-TX) | 1 | 0.56 | --- | CJ1W-SPU01-V2 | UC1, CE |
| | SPU-Console | Functions: Unit settings, sampling settings, etc., for High-speed Data Collection Units (required for making settings for this Unit) OS: Microsoft Windows 10 (32 bit/64 bit) Microsoft Windows 8.1 (32 bit/64 bit) Microsoft Windows 8 (32 bit/64 bit) Microsoft Windows 7 (32 bit/64 bit) | | | | | WS02-SPTC1-V2 | |
| | SPU Unit Data Management Middleware | Function: Data files collected by SPU Unit Data Management Middleware are automatically acquired at the personal computer, and can be registered in a database. | | | 1 license | WS02-EDMC1-V2 | | --- |
| | | OS: Microsoft Windows 10 (32 bit/64 bit) Microsoft Windows 8.1 (32 bit/64 bit) Microsoft Windows 8 (32 bit/64 bit) Microsoft Windows 7 (32 bit/64 bit) Microsoft Windows Server 2012 Microsoft Windows Server 2008 | | | 5 licenses | WS02-EDMC1-V2L05 | | |
| | Memory Cards | Flash memory, 128 MB | | | Note: Memory Card is required for data collection. | HMC-EF183 | | --- |
| | Flash memory, 256 MB | | | HMC-EF283 | | | | |
| | Flash memory, 512 MB | | | HMC-EF583 | | | | |